Canvas Fasteners	968 - 969
-------------------------	------------------

Fasteners	Fasteners	970 - 978
	Fastmount	979
	Locking Wire & Plugs	980

Rigging Knives & Sharpeners	980 - 981
----------------------------------------	------------------

Tools	Hand Tools	981
	Scrapers	982
	Screwdrivers	983
	Drill Bits	984

Sea-Dog Canvas Fasteners

Nickel plated brass.
Socket and back plate 7/32"
SED 299101-1 3/pkg



Stud-2 prong clinch & washer
SED 299102-1 4/pkg



Stud-eyelet type & washer
SED 299103-1 4/pkg



Stud, #8 wood screw, 1/2"
SED 299104-1 5/pkg



Stud, #8 sheet metal screw, 3/8"
SED 299105-1 5/pkg



Stud-#8 sheet metal screw 5/8"
SED 299106-1 5/pkg



Stud-8/32" machine screw 3/8"
SED 299107-1 5/pkg



Snap cap 1/4" & socket
SED 299108-1 6/pkg



Snap cap 5/16" & socket
SED 299109-1 6/pkg

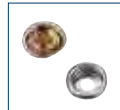

Snap stud standard & snap post 1/4"
SED 299110-1 6/pkg



Snap stud, #8 sheet metal screw, 3/8"
SED 299111-1 6/pkg



Snap stud, #8 sheet metal screw, 5/8"
SED 299112-1 6/pkg



Snap stud, #10/32 machine screw 3/8"
SED 299115-1 5/pkg



Twist stud
SED 299116-1 2/pkg



Snap turnbuckle-2 prong
clinch & backplate
SED 299117-1 2/pkg



Snap turnbuckle eyelet & washer
SED 299118-1 2/pkg



Snap turnbuckle #7
brass wood screw, 5/8"
SED 299119-1 2/pkg



Sea-Dog Canvas Fasteners

Stainless steel windshield clip-3/4" base
SED 299124-1 4/pkg



Stainless steel windshield clip-7/8" base
SED 299125 Bulk
SED 299125-1 4/pkg

Perko Curtain Fasteners

Nickel plated brass.
PER 994-000-NKL Flanged stud
PER 996-000-NKL Eyelet
PER 997-000-NKL Washer



Perko "Lift Type" Fasteners

Nickel plated. No. 117 stud is stainless steel with a 5/8" self tapping screw.

PER 117-000-ST Stud
PER 116-000-NKL Socket
PER 118-000-NKL Clinch plate
PER 62-000-NKL Clinch washer



Perko Button Fasteners

Nickel plated. No. 869 stud is stainless steel with a 5/8" self tapping screw. For canvas to surface, use No. 869, 896, 898. For canvas to canvas, use No. 896, 898, 901, 907.

PER 896-000-NKL Button
PER 901-000-NKL Stud
PER 907-000-NKL Eyelet
PER 898-000-NKL Socket
PER 869-000-ST Stud



S&J Canvas Fasteners

Nickel plated brass. Each sealed plastic package, with descriptive header card, contains a varying quantity to allow each package to retail for the same amount.

Canvas Fasteners:

S&J 560011	Socket & cinch plate	3/pkg
S&J 560021	Stud & cinch plate	4/pkg
S&J 560031	Eyelet stud & washer	4/pkg
S&J 560041	Stud #8 Wood screw	5/pkg
S&J 560051	Stud #8 SMS 3/8	5/pkg
S&J 560061	Stud #8 SMS 5/8	5/pkg
S&J 560071	Stud #8-32 MS 3/8	5/pkg

Snap Canvas Fasteners:

S&J 560081	1/4 Barrel & socket	6/pkg
S&J 560091	11/64 Barrel & socket	6/pkg
S&J 560101	Stud eyelet 10	6/pkg
S&J 560111	Stud #8 SMS 3/8	6/pkg
S&J 560121	Stud #8 SMS 5/8	6/pkg
S&J 560131	#7 Woodscrew 3/8	6/pkg
S&J 560141	#7 Woodscrew 5/8	6/pkg
S&J 560151	Stud #10-32 M/S 3/8	5/pkg

Twist & Curtain Fasteners:

S&J 560161	Twist stud 2 Hole	2/pkg
S&J 560171	Double prong twist	2/pkg
S&J 560181	Eyelet & washer	4/pkg
S&J 560191	Twist stud tool set	2/pkg
S&J 560201	Hand punch & base	1/pkg



S&J Extend-A-Snap Canvas Fasteners

- Avoid shrinkage of canvas covers & tarps
- Gain 3/4" on each reach
- Simply snap male to the canvas and the female end to the boat

S&J 560261	4/pkg
-----------------------	-------



S&J E-Z Grommets

Self sealing eyelet kit for plastic sheets, canvas tarps, and heavy cloth. Kit includes: 6 eyelets 1/2", steel hole making tool, and wood base.

S&J 960102	Blue
-----------------------	------



Taylor "Dot" Fastener Tool

Punch and die for attaching buttons, sockets, studs and eyelets to canvas. Easy to use. Instructions included. Comes on display card.

TAY 1360



Sea-Dog Canvas Snap Tool

Canvas snap hand punch & base. **SED 299120-1**



Hex Head Bolts, Hot Dipped Galvanized, Coarse Thread

Order (eg.) FAS BHG 14x112

Length in inches

Part #	Size	1	1-1/2	2	2-1/2	3	3-1/2	4	5	6	7	8	12
FAS BHG 1/4			•		•	•							
FAS BHG 5/16		•	•	•	•	•							
FAS BHG 3/8		•	•	•	•	•	•	•	•	•			
FAS BHG 1/2			•			•		•		•	•	•	
FAS BHG 3/4												•	•



Hex Head Bolts, Stainless Steel (18-8), Coarse Thread

Order (eg.) FAS BH 3/8 x 3

Length in inches

Part #	Size	1/2	5/8	3/4	1	1-1/4	1-1/2	1-3/4	2	2-1/4	2-1/2	3	3-1/2	4	4-1/2	5	5-1/2	6	7	7-1/2	8	
FAS BH 1/4		•	•	•	•	•	•	•	•	•	•	•	•	•	•	•						
FAS BH 5/16				•	•	•	•	•	•		•	•	•	•	•							
FAS BH 3/8				•	•	•	•	•	•		•	•	•	•	•	•	•	•	•	•	•	•
FAS BH 7/16					•	•	•		•		•	•										
FAS BH 1/2					•	•		•	•		•	•	•	•	•	•	•			•	•	•
FAS BH 5/8							•		•		•	•	•	•	•	•						
FAS BH 3/4									•		•	•	•	•		•						

Carriage Bolts, Hot Dipped Galvanized, Coarse Thread

Order (eg.) FAS BCG 3/8 x 3

Length in inches

Part #	Size	1	1-1/2	2	2-1/2	3	3-1/2	4	4-1/2	5	5-1/2	6	7	8	9	10	12
FAS BCG 1/4			•	•	•	•	•	•		•		•					
FAS BCG 5/16			•	•	•	•	•	•	•	•	•	•	•	•			
FAS BCG 3/8		•	•		•	•	•		•	•	•	•	•	•			
FAS BCG 1/2								•		•		•	•	•	•	•	•
FAS BCG 5/8										•				•			

Carriage Bolts, Stainless Steel (18-8), Coarse Thread

Order (eg.) FAS BC 3/8 x 3

Length in inches

Part #	Size	3/4	1	1-1/4	1-1/2	2	2-1/2	3	3-1/2	4	4-1/2	5	6
FAS BC 1/4		•	•	•	•	•	•	•	•	•	•	•	•
FAS BC 5/16					•	•	•	•	•	•	•	•	•
FAS BC 3/8					•	•	•	•	•	•	•	•	•
FAS BC 1/2						•	•	•	•	•		•	•



Lag Screws, Hot Dipped Galvanized, Hex Head

Order (eg.) FAS LG 1/4 x 3

Length in inches

Part #	Size	1-1/2	2	2-1/2	3	3-1/2	4	4-1/2	5	6	7	8
FAS LG 1/4		•	•	•	•		•					
FAS LG 5/16		•	•	•	•	•	•		•			
FAS LG 3/8			•	•	•	•	•	•	•	•		
FAS LG 1/2					•	•	•		•	•	•	•



Lag Screws, Stainless Steel (18-8), Hex Head

Order (eg.) FAS L 1/4 x 3

Length in inches

Part #	Size	1	1-1/2	2	2-1/2	3	3-1/2	4	5	6
FAS L 1/4		•	•	•	•	•		•		
FAS L 5/16		•	•	•	•	•		•	•	•
FAS L 3/8			•	•	•	•	•	•	•	•
FAS L 1/2				•		•		•	•	•

Machine Screws, Stainless Steel (18-8), Flat Head, Slot, Coarse Thread

Order (eg.) FAS MF 10-24 x 1

Length in inches

Part #	Size	1/2	3/4	1	1-1/4	1-1/2	1-3/4	2	2-1/2	3	3-1/2	4	4-1/2	6
FAS MF 6-32		•	•	•	•	•								
FAS MF 8-32		•	•	•	•	•	•	•						
FAS MF 10-24		•	•	•	•	•	•	•	•	•				
FAS MF 10-32		•	•	•	•	•	•	•						
FAS MF 1/4		•	•	•	•	•	•	•	•	•	•	•	•	•
FAS MF 5/16				•	•	•		•	•	•	•	•		
FAS MF 3/8				•		•		•	•		•	•		

**Machine Screws, Stainless Steel (18-8), Oval Head, Slot, Coarse Thread**

Order (eg.) FAS MO 10-24 x 1

Length in inches

Part #	Size	1/2	3/4	1	1-1/4	1-1/2	1-3/4	2	2-1/2	3
FAS MO 6-32			•	•	•	•				
FAS MO 8-32		•	•	•	•	•		•		
FAS MO 10-24		•	•	•	•	•		•	•	•
FAS MO 10-32		•	•	•	•	•		•		
FAS MO 1/4			•	•	•	•	•			•

**Machine Screws, Stainless Steel (18-8), Round Head, Socket, Coarse Thread**

Order (eg.) FAS MRS 10-24 x 1

Length in inches

Part #	Size	1/2	3/4	1	1-1/4	1-1/2	2
FAS MRS 10-24			•	•	•	•	
FAS MRS 10-32		•					
FAS MRS 1/4			•	•		•	•

**Machine Screws, Stainless Steel (18-8), Pan Head, Slot, Coarse Thread**

Order (eg.) FAS MP 1/4 x 4

Length in inches

Part #	Size	1/2	1	1-1/2	2	3
FAS MP 6-32		•	•	•		
FAS MP 8-32		•	•	•	•	
FAS MP 10-24		•	•	•	•	•
FAS MP 10-32			•	•	•	
FAS MP 1/4			•	•	•	•

**Machine Screws, Stainless Steel (18-8), Flat Head Hex Socket, Coarse Thread**

Order (eg.) FAS MFA 1/4 x 1

Length in inches

Part #	Size	3/4	1	1-1/4	1-1/2	2
FAS MFA 1/4		•	•	•	•	•
FAS MFA 5/16		•	•	•	•	•
FAS MFA 3/8		•	•	•	•	•
FAS MFA 1/2			•	•		



Machine Screws, Stainless Steel (18-8), Oval Head, Philips Coarse Thread

Order (eg.) FAS MOP 1/4 x 1-1/2

Length in inches

Part #	Size	1/2	3/4	1	1-1/4	1-1/2	2	3
FAS MOP 6-32				•				
FAS MOP 8-32		•	•	•	•	•	•	
FAS MOP 10-24			•	•		•	•	
FAS MOP 10-32		•	•	•		•		
FAS MOP 1/4			•	•	•	•	•	•



Machine Screws, Stainless Steel (18-8), Flat Head, Philips Coarse Thread

Order (eg.) FAS MFP 10-24 x 1

Length in inches

Part #	Size	1/2	3/4	1	1-1/4	1-1/2	1-3/4	2	2-1/2	3
FAS MFP 6-32		•	•	•		•				
FAS MFP 8-32		•	•	•	•	•		•		
FAS MFP 10-24		•	•	•	•	•	•	•	•	•
FAS MFP 10-32		•	•	•	•	•		•		
FAS MFP 1/4			•	•	•	•		•	•	•



Machine Screws, Stainless Steel (18-8), Pan Head, Philips Coarse Thread

Order (eg.) FAS MPP 10-24 x 2

Length in inches

Part #	Size	1/2	3/8	3/4	1	1-1/4	1-1/2	2	2-1/2	3
FAS MPP 6-32		•		•	•		•	•		
FAS MPP 8-32		•	•	•	•	•	•	•		
FAS MPP 10-24		•		•	•	•	•	•	•	
FAS MPP 10-32		•		•	•		•	•		
FAS MPP 1/4		•		•	•	•	•	•	•	•



Machine Screws, Stainless Steel (18-8), Round Head, Slot Coarse Thread

Order (eg.) FAS MR 10-32 x 1

Length in inches

Part #	Size	1/4	5/16	3/8	1/2	5/8	3/4	1	1-1/4	1-1/2	1-3/4	2	2-1/2	3	3-1/2	4	4-1/2	5	6
FAS MR 6-32		•			•		•	•	•	•		•							
FAS MR 8-32					•		•	•	•	•	•	•							
FAS MR 10-24			•	•	•	•	•	•	•	•	•	•	•	•					
FAS MR 10-32					•		•	•	•	•	•	•							
FAS MR 1/4					•		•	•	•	•	•	•	•	•	•	•	•	•	•
FAS MR 5/16							•	•	•	•		•	•	•	•				
FAS MR 3/8							•	•		•		•	•	•					



Hex Head Bolts, Stainless Steel (18-8), Metric

Order (eg.) FAS BH 8 x 30

Length in millimetres

Part #	Size	12	16	20	25	30	40	45	50	60	70	80
FAS BH 5							•		•			
FAS BH 6		•		•	•		•	•	•			•
FAS BH 8			•	•	•	•						
FAS BH 10				•	•	•	•		•			
FAS BH 12					•	•	•		•	•	•	

**Hex Nuts, Stainless Steel (18-8)**

Order (eg.) FAS N 6-32

Imperial Sizes:

FAS N 6-32
 FAS N 8-32
 FAS N 10-32
 FAS N 10-24
 FAS N 1/4
 FAS N 5/16
 FAS N 3/8
 FAS N 7/16
 FAS N 1/2
 FAS N 5/8
 FAS N 3/4
 FAS N 7/8
 FAS N 1

**Metric**

(All measurements are in millimetres)

FAS N5MM
 FAS N6MM
 FAS N8MM
 FAS N10MM
 FAS N12MM

Hex Nuts, Galvanized

FAS NG 1/4
 FAS NG 5/16
 FAS NG 3/8
 FAS NG 1/2
 FAS NG 5/8
 FAS NG 3/4

**Hex Nuts, Brass**

FAS NB 1/4
 FAS NB 5/16
 FAS NB 3/8
 FAS NB 1/2
 FAS NB 5/8
 FAS NB 3/4

Lock Nuts, Stainless Steel (18-8)

Order (eg.) FAS NL 1/4

Imperial Sizes:

FAS NL 6-32
 FAS NL 8-32
 FAS NL 10-32
 FAS NL 10-24
 FAS NL 1/4
 FAS NL 5/16
 FAS NL 3/8
 FAS NL 7/16
 FAS NL 1/2
 FAS NL 5/8
 FAS NL 3/4

**Metric Sizes:**

(All measurements are in millimetres)

FAS NL 6MM
 FAS NL 8MM
 FAS NL 10MM
 FAS NL 12MM

Acorn Nuts, Stainless Steel (18-8)

FAS NA 6-32
 FAS NA 8-32
 FAS NA 10-24
 FAS NA 10-32
 FAS NA 1/4
 FAS NA 5/16
 FAS NA 3/8
 FAS NA 1/2

**Wing Nuts, Stainless Steel (18-8)**

FAS NW 8-32
 FAS NW 10-24
 FAS NW 10-32
 FAS NW 1/4
 FAS NW 5/16
 FAS NW 3/8



Flat Washers, Stainless Steel (18-8)

Imperial Sizes:

- FAS W 6
- FAS W 8
- FAS W 10
- FAS W 12
- FAS W 1/4
- FAS W 5/16
- FAS W 3/8
- FAS W 5/8
- FAS W 7/16
- FAS W 1/2
- FAS W 3/4
- FAS W 1



Metric Sizes:

All sizes are in millimetres

- FAS W 6MM
- FAS W 8MM
- FAS W10MM
- FAS W12MM

Flat Washers, Hot Dipped Galvanized

- FAS WG-1/4
- FAS WG 5/16
- FAS WG 3/8
- FAS WG 1/2
- FAS WG 5/8
- FAS WG 3/4



Fender Washers, Stainless Steel (18-8)

- FAS WF 10X3/4
- FAS WF 10x1
- FAS WF 1/4"x1-1/4
- FAS WF 5/16"x1-1/2
- FAS WF 3/8"x1-1/2
- FAS WF 1/2"x2



Lock Washers, Stainless Steel (18-8)

Imperial Sizes:

- FAS WL 6
- FAS WL 8
- FAS WL 10
- FAS WL 1/4
- FAS WL 5/16
- FAS WL 3/8
- FAS WL 7/16
- FAS WL 1/2
- FAS WL 5/8
- FAS WL 3/4



Metric Sizes:

- FAS WL 6MM
- FAS WL 8 MM
- FAS WL 10 MM
- FAS WL 12 MM

Finishing Washers, Stainless Steel (18-8)

- FAS WC #6
- FAS WC #8
- FAS WC #10
- FAS WC #12
- FAS WC 1/4



Oval Head Screws, Stainless Steel (18-8), Square Socket



Order (eg.) FAS SO 6x1

Length in inches

Part #	Size	1/2	3/4	1	1-1/4	1-1/2	1-3/4	2
FAS SO 6		•	•	•	•			
FAS SO 8		•	•	•	•	•	•	•
FAS SO 10			•	•	•	•		•
FAS SO 12				•	•	•		•
FAS SO 14				•				

Oval Head Screws, Stainless Steel (18-8), Philips



Order (eg.) FAS SOP8x1

Length in inches

Part #	Size	1/2	3/4	1	1-1/4	1-1/2	2	2-1/2
FAS SOP 6			•	•				
FAS SOP 8		•	•	•	•	•		
FAS SOP 10			•	•	•	•		
FAS SOP 12				•	•	•	•	
FAS SOP 14								•

Pan Head Screws, Stainless (18-8), Philips



Order (eg.) FAS SPP 10x1

Length in inches

Part #	Size	1/2	3/4	1	1-1/4	1-1/2
FAS SPP 8		•	•	•	•	
FAS SPP 10		•	•	•	•	•
FAS SPP 12			•			
FAS SPP 14				•		•

Pan Head Screws, Stainless Steel (18-8), Square Socket

Order (eg.) FAS SP12x3/4

Length in inches

Part #	Size	1/2	5/8	3/4	1	1-1/4	1-1/2	1-3/4	2	2-1/2	3
FAS SP 4		•		•							
FAS SP 6		•	•	•	•	•	•				
FAS SP 8		•	•	•	•	•	•	•	•		
FAS SP 10		•		•	•	•	•	•	•	•	•
FAS SP 12				•	•	•	•		•	•	
FAS SP 14					•	•	•		•	•	•

**Flat Head Screws, Stainless Steel (18-8), Square Socket**

Order (eg.) FAS SF 10

Length in inches

Part #	Size	1/2	5/8	3/4	7/8	1	1-1/4	1-1/2	1-3/4	2	2-1/2	3
FAS SF 4		•		•	•	•						
FAS SF 6		•	•	•		•	•	•				
FAS SF 8		•	•	•		•	•	•	•	•	•	•
FAS SF 10		•		•		•	•	•	•	•	•	•
FAS SF 12				•		•	•	•	•	•	•	•
FAS SF 14						•	•	•	•	•	•	•

**Flat Head Screws, Brass, Square Socket**

Order (eg.) FAS SFB 10x1

Length in inches

Part #	Size	1/2	3/4	1	1-1/4	1-1/2	1-3/4	2	2-1/2
FAS SFB 4		•	•						
FAS SFB 5		•	•						
FAS SFB 6		•	•	•	•				
FAS SFB 8			•	•	•	•			
FAS SFB 10			•	•	•	•	•	•	
FAS SFB 12						•		•	•

**Truss Head Screws, Stainless Steel (18-8), Philips**

Order (eg.) FAS STP 6x1

Length in inches

Part #	Size	1/2	5/8	3/4	1	1-1/4	1-1/2
FAS STP 6		•	•	•	•		
FAS STP 8		•	•	•	•	•	
FAS STP 10		•	•	•	•	•	•

**Round Head Screws, Brass, Square Socket**

Order (eg.) FAS SRB 6x1

Length in inches

Part#	Size	1/2	3/4	1	1-1/4	1-1/2
FAS SRB 5		•				
FAS SRB 6		•	•			
FAS SRB 8			•	•	•	
FAS SRB 10				•		•



Set Screws, Stainless Steel, Hex Socket



Order (eg) FAS MA 8-32

Length in inches

Part #	Size	3/16	1/4	3/8	1/2	3/4	1
FAS MA 8-32		•	•				
FAS MA 10-32		•					
FAS MA 1/4-28		•					
FAS MA 1/4-20		•	•				
FAS MA 5/16-18				•	•		
FAS MA 3/8-16					•	•	•
FAS MA 1/2-13					•		

Sea-Dog Stainless Set Screws



Packages of 10 replacement set screws for handrail, stanchion, base rail, top, tee and elbow fittings.

- 1/4"-28 x 3/16"

SED 299999-1 10/pkg

Canadian Tack and Nail Silicon Bronze Ring Nails

These annular ring nails offer superb holding power and corrosion resistance. Ideal for small boat framing and planking as well as laminated decking. Sold in 500 gram packages. Length is soft conversion from metric.



Part #	Length	Approx Qty/500g
NLS16MMX14GA	5/8"	1000
NLS19MMX14GA	3/4"	705
NLS22MMX14GA	7/8"	590
NLS25MMX14GA	1"	474
NLS32MMX14GA	1-1/4"	412
NLS38MMX12GA	1-1/2"	276

Threaded Rods

36" lengths, coarse thread.



18-8 Stainless Steel

- REA SSRR 10-32
- REA SSRR 10-24
- REA SSRR 1/4
- REA SSRR 5/16
- REA SSRR 3/8
- REA SSRR 1/2
- REA SSRR 5/8
- REA SSRR 3/4

Plated Steel

- REA ZRR 10-24
- REA ZRR 1/2
- REA ZRR 5/8
- REA ZRR 3/4

S&J O-Ring Kit

Contains 30 pieces:

- 6 ea x 3/8"
- 8 ea x 7/16"
- 8 ea x 9/16"
- 4 ea x 5/8"
- 4 ea x 11/16"



S&J 970070

S&J Nylon Washers

Part #	Size	Qty/Bag
S&J 650011	1/4"	10
S&J 650021	5/16"	8
S&J 650031	3/8"	7
S&J 650041	1/2"	6
S&J 650051	5/8"	4
S&J 650061	3/4"	2



Beckson Barrel Nuts

Nickel plated brass barrel nuts recommended for installations where a nice finish is required on each side.



Part #	Overall Length	Shank Dia	Fastener Size	Finish
BEC BB187-01-CHR	.375"	.25"	10/24	Chrome
BEC BB187-02-CHR	.50"	.25"	10/24	Chrome
BEC BB187-11-BLK	.375"	.25"	10/24	Black
BEC BB250-01-CHR	.50"	.32"	1/4"-20	Chrome

S&J Products Aluminum Blind Rivets

Part #	Description	Qty/Bag
S&J 460031	1/8" x 1/4"	18
S&J 460051	1/8" x 3/8"	15
S&J 460101	5/32" x 1/4"	12
S&J 460111	5/32" x 3/8"	10
S&J 460171	3/16" x 1/2"	8
S&J 460181	3/16" x 5/8"	7



S&J Products Stainless Steel Blind Rivets

Part #	Description	Qty/Bag
S&J 470031	1/8" x 1/4"	10
S&J 470051	1/8" x 3/8"	8
S&J 470101	5/32" x 1/4"	6
S&J 470111	5/32" x 3/8"	4
S&J 470151	3/16" x 1/4"	4
S&J 470161	3/16" x 5/8"	3



S&J Stainless Steel Cotter Pins

Part #	Size	Per Bag
S&J 360011	1/16" x 1/2"	24
S&J 360021	1/16" x 3/4"	18
S&J 360031	1/16" x 1"	18
S&J 360051	1/16" x 1-1/2"	10
S&J 360061	1/16" x 2"	6
S&J 360071	3/32" x 5/8"	10
S&J 360081	3/32" x 3/4"	10
S&J 360091	3/32" x 1"	8
S&J 360111	3/32" x 1-1/2"	6
S&J 360131	3/32" x 2-1/2"	3
S&J 360141	1/8" x 3/4"	7
S&J 360151	1/8" x 1"	6
S&J 360161	1/8" x 1-1/4"	4
S&J 360171	1/8" x 1-1/2"	4
S&J 360181	1/8" x 1-3/4"	4
S&J 360191	1/8" x 2"	3
S&J 360211	1/8" x 2-1/2"	3
S&J 360251	5/32" x 1-1/2"	3
S&J 360271	5/32" x 2"	3



Stainless Steel Cotter Pins

Order (eg.) FASC1/8x1
Round with extended prong, type 18-8 S/S.

Part #	Length				
	3/4"	1"	1-1/4"	1-1/2"	2"
FASC 1/16		•	•	•	
FASC 3/32	•	•	•	•	•
FASC 1/8	•	•	•	•	•
FASC 5/32	•	•	•	•	•
FASC 3/16		•		•	•
FASC 1/4					•



Sea-Dog Stainless Steel Cotter Pins

Round with extended prong, type 316 stainless steel. Display packaged. 1/16" x 11/16"

SED 193710-1 4/ pkg



S&J Stainless Steel Hitch Pins

Part #	Max Dia x Length	Per pkg
S&J 500011	3/16" x 19/32"	3
S&J 500021	3/16" x 1"	3
S&J 500031	1/4" x 1-3/16"	3
S&J 500041	3/8" x 1-9/16"	2
S&J 500051	1/4" x 1-5/8"	2
S&J 500061	1/4" x 2-5/16"	2



Sea-Dog Stainless Steel Release Pins

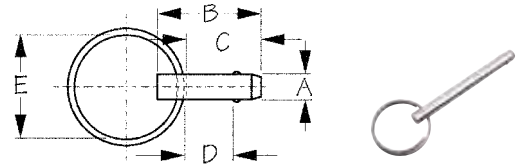

Part #	A	B	C	D	E
SED 193410	1/4"	1"	3/4"	7/16"	1"
SED 193410-1	"	"	"	"	"
SED 193415	1/4"	1-1/2"	1-1/4"	7/8"	1"
SED 193415-1	"	"	"	"	"
SED 193420	1/4"	2-1/16"	1-7/8"	1-1/2"	1"
SED 193420-1	"	"	"	"	"
SED 193425	1/4"	2-1/2"	2-3/16"	1-15/16"	1"
SED 193425-1	"	"	"	"	"

Suffix (-1) indicates display package (2/pkg)



Sea-Dog Quick Disconnect Pins

Stainless steel release pins replaces non-threaded pins in hinges for quick access. Pin length 1-1/2".

SED 299980-1 Stepped shaft
SED 299981-1 Straight shaft



Johnson Marine Circular Rings

Stainless steel ring pins. Sizes are ID.

JHD R-1-100 For 3/16" pins
JHD R-2-1-100 For 3/16" & 1/4" pins
JHD R-2-100 For 3/16" & 1/4" pins (pig tail)
JHD R-3-100 For 1/4" & 3/8" pins

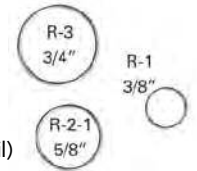

Johnson Marine Safety Pin

Stainless steel. Usage 3/16" & 1/4".

JHD SP-1

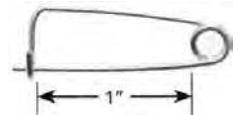

S&J Stainless Steel Cotter Rings and Pins

Part #	Size	Per pkg
S&J 361011	Fits 3/16" clevis pin	10
S&J 361021	Fits 1/4" clevis pin	6
S&J 361031	Fits 5/16" clevis pin	4
S&J 361041	Fits 3/8" clevis pin	4
S&J 361051	Fits 1/2" & 5/8" clevis pin	4



Sea-Dog Stainless Steel Split Rings



316 Stainless steel wire.

Part #	Gauge	Diameter	
SED 193561	1/32"	11/32"	Each
SED 193562-1	1/16"	15/32"	4/pkg
SED 193563-1	1/16"	5/8"	4/pkg
SED 193564-1	3/32"	3/4"	3/pkg

Blue Wave Split Rings

Highly polished AISI 316 stainless steel construction.

Part #	Dim	D
BLU 070601	1/32"	7/16"
BLU 070602	3/64"	19/32"
BLU 070603	1/16"	3/4"
BLU 070604	5/64"	29/32"

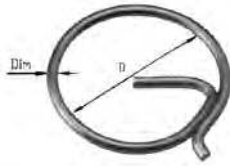

▶ *Also See:* Smart Pins pg 727

S&J Stainless Steel Clevis Pins

Part #	Size	Per pkg
S&J 370081	3/16" x 3/4"	2
S&J 370091	3/16" x 7/8"	2
S&J 370101	3/16" x 1"	2
S&J 370111	3/16" x 1-1/8"	2
S&J 370211	1/4" x 3/4"	2
S&J 370241	1/4" x 1"	2
S&J 370271	1/4" x 1-1/4"	2
S&J 370341	5/16" x 3/4"	1
S&J 370361	5/16" x 1"	1
S&J 370371	5/16" x 1-1/4"	1
S&J 370391	5/16" x 1-1/2"	1
S&J 370401	5/16" x 2"	1
S&J 370471	3/8" x 1"	1
S&J 370501	3/8" x 1-1/2"	1
S&J 370521	3/8" x 2"	1
S&J 370621	1/2" x 1"	1
S&J 370671	1/2" x 1-1/2"	1
S&J 370681	1/2" x 2"	1



▶ *Also See:* Clevis Pins pg 724

Western Pacific Trading Stainless Steel Locking Wire

Clam packed coiled lengths or in a 1 lb feeder box.

- WPT 30085 .032 coil x 10'
- WPT 30086 .041 coil x 10'
- WPT 30087 .032 box x 340'
- WPT 30088 .041 box x 225'



Stainless Steel General Purpose Wire

18-8 stainless steel wire. 18 gauge (.047) by approx. 157 feet per 1 lb roll.

WES SSW-1



S&J Toggles

Stainless steel toggles
A mounting aid to fasten a variety of marine hardware such as cleats, deck chairs, pedestal bases and chocks when the other side is inaccessible.

Part #	Size	Pkg
S&J 540031	1/4" without screws	2
S&J 540051	3/8" without screw	1



S&J Super Toggler Anchors

A medium duty blind fastener for many of your marine mounting needs such as fire extinguishers, compasses, and hooks.

Part #	Size	Pkg
S&J 540071	1/8" x 1/4"	4
S&J 540081	3/8" - 1/2"	4

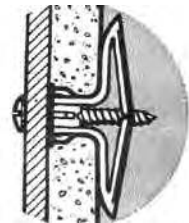

S&J Alligator Anchors

A light duty blind fastener for many marine mounting uses. 4/pkg.

S&J 540111 1/4"

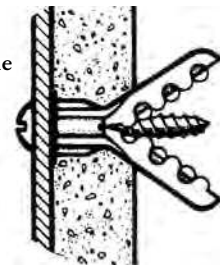

Fastmount Panel Mounting Systems

Revolutionizes the mounting of ceiling, wall, floor and other panels. The Fastmount PC01 clips used in the system are specifically designed and developed to meet the demanding requirements of the marine industry. Fastmount is an international multi award winning system and is used by more than 300 boatyards in over 35 countries.

- Quick install
- Upholstered panels
- New builds
- Internal & external
- Compatible with Velcro
- Removable
- Strong 5kg per clip
- Precise positioning
- Painted panels
- Refits

The Fastmount system provides a superior ceiling finish with perfect panel alignment every time. Panels can quickly & easily be removed and refitted



Tools

- FLP CP-01** Center point insert
- FLP CT-01** Drill 10mm
- FLP CT-03** Installer for female half
- FLP CT-04** Installer for male half
- FLP CT-05** Ppanel removal tool
- FLP CT-07** Step drill 16.8 mm, tung tipped
- FLP CT-09** Panel drill 10mm, forstner type
- FLP CT-10** Installer for male half PC-M2H

- FLP PC-01** Panel clip set
- FLP PC-F1** Panel clip-female half
- FLP PC-M1** Panel clip-male half
- FLP PC-M2H** Upholstery clip HD, black male
- FLP PC-SF1** Panel clip-s/m female half
- FLP PC-SM2** Panel clip-s/m male half

Tool Kits

- FLP CT-06T** Boat kit w/toolset & PC-01
- FLP CT-08** Yard kit 5 tools

CT-08



CT-06



CP-01



CT-01



CT-03



CT-04



CT-05



CT-07



CT-09



Typical installation details

Partially exploded section through showing typical installation

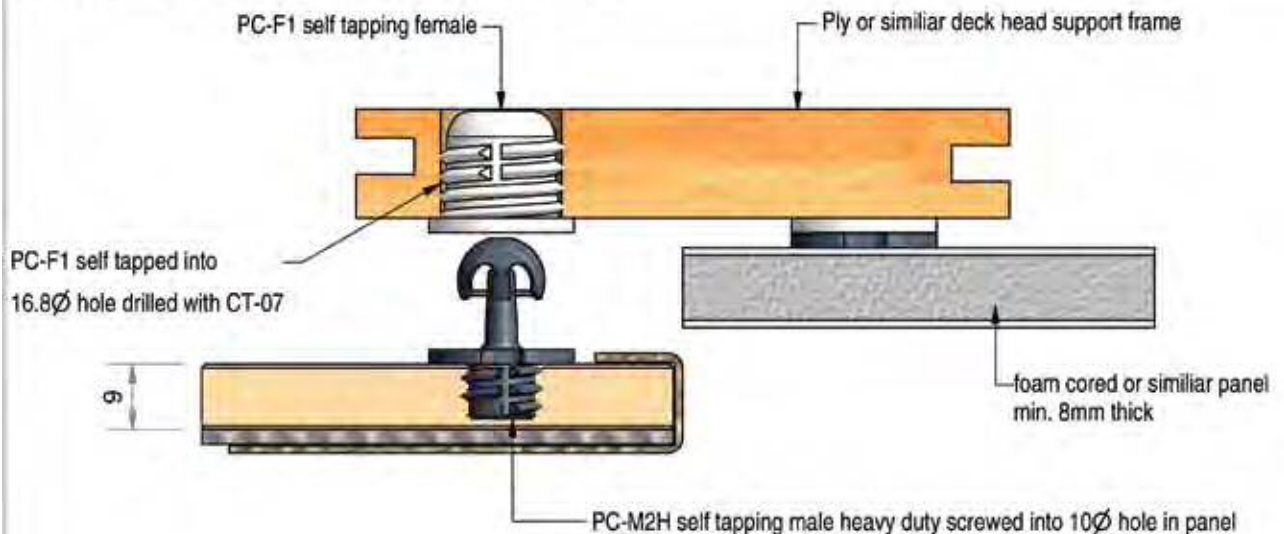

S&J Quality Teak Deck Plugs

Attractively packaged teak deck plugs.



Part #	Size	Qty/Bag	Bags/Box
S&J 603011	3/16"	18	10
S&J 603021	1/4"	15	10
S&J 603031	5/16"	12	10
S&J 603041	3/8"	12	10
S&J 603051	1/2"	10	10
S&J 603061	5/8"	8	10

MRT Deck Plugs

Accurately cut from quality stock for precise control of the finished surface.

*Other wood types and sizes from 1/4" to 2-1/2" are available on request.



Pine	Mahogany	Teak
-	DEC 1/4MC	DEC 1/4TC
-	DEC 5/16MC	DEC 5/16TC
DEC 3/8PC	DEC 3/8MC	DEC 3/8TC
-	-	DEC 7/16TC
DEC 1/2PC	DEC 1/2MC	DEC 1/2TC
DEC 5/8PC	DEC 5/8MC	DEC 5/8TC
DEC 3/4PC	DEC 3/4MC	DEC 3/4TC
DEC 7/8PC	DEC 7/8MC	-
DEC 1PC	-	-

C.S. Osborne Sailmaker's Needles

Manufactured in England to Osbornes' exacting standards. Nickel-plated fine steel with triangular point.
Part No. (Gauge & Length)

Straight:

OSE 509-9G-4"	4"
OSE 509-10G-33/4"	3-3/4"
OSE 509-11G-31/2"	3-1/2"
OSE 509-12G-31/4"	3-1/4"
OSE 509-13G-3"	3"
OSE 509-14G-23/4"	2-3/4"
OSE 509-15G-21/2"	2-1/2"
OSE 509-16G-23/8"	2-3/8"
OSE 509-17G-21/4"	2-1/4"



Bent:

OSE 508-9G-6"	6"
OSE 508-10G-5"	5"

C.S. Osborne Sail Palms

Fine quality rawhide palms of English manufacture.

The iron thimble is hide bound, as are both joints, riveted.



OSE 265-L	Left hand
OSE 265-R	Right hand

FASTENERS

Wichard Colour Glo Knives

Located in Thiers, the French cutlery capital for more than five centuries, Wichard knows exactly how to use stainless steels in the marine environment. All these knives have been carefully designed for styling and functionality. For improved usefulness Wichard blades are half serrated. This unique feature permits cutting of heavy material and modern composite rope without dulling the blade.

These high-quality stainless steel knives are available in assorted colours. A tremendous value combining strength, corrosion resistance, appealing colour and design. Three styles available.

Blade, Shackle Key w/ Bottle Opener & Spike

WIC 10062	Fluorescent
WIC 10063	Black

Blade, Shackle Key w/ Bottle Opener

WIC 10051	Green
WIC 10052	Fluorescent
WIC 10053	Black

Single Blade - 2-3/4" long

WIC 10042	Fluorescent
WIC 10043	Black



Wichard One-Handed Knife

Stainless steel, high quality knife with quick opening shackler and safety liner lock on the blade. Easy one-hand operation ensures reliability even under difficult conditions.

WIC 10031



Wichard Shackler

This stainless steel shackle tool is 3-1/2" long and features a bottle opener and pry points as part of its design.

WIC 10303



Wichard Sheath

Fabric sheath for knives.

WIC 10022



Davis Rigging Knives

Made entirely of top quality stainless steel with dura edged blades. Telo Rigging knives are tools that yachtsmen will be proud to own, yet are affordable.

#1550 Standard rigging knife comes with a marlin spike

#1551 Deluxe rigging knife comes with a marlin spike, shackle key and screwdriver.

#1555 Yachtsman pocket knife comes with a marlin spike and shackle key

- DIN 1550 Standard
- DIN 1551 Deluxe
- DIN 1555 Yachtsman



Scotty Knife Sharpener

The ultimate sharpening device. Made of molded plastic with 2 tungsten carbide blades that can be rotated to 8 different positions to extend sharpening life.

- SCO 990 Sharpener
- SCO SBLADE/0990 Spare blade (each) (order 2 for blade replacement)



Olfa Utility Knife

For cutting cardboard, fibreglass, vinyl sheets, etc. Retractable, snap-off blade and large comfortable handle with rubber pad inlay on one side. Suits use with gloves. Supplied with three blades.

- OLF L-2 Utility knife
- OLF LB-50B 50 Replacement blades
- OLF LBB-50B 50 Replacement blades black steel



Wexford Regular Caulking Gun

A medium duty, "skeleton" style caulking gun. For 325 ml spouted cartridge.

TOO 215



Heavy-Duty Caulking Gun

High quality caulking gun. Durable construction to withstand heavy use. Fits 325 ml spouted cartridge.

TOO 110



Heavy-Duty Caulking Guns

Heavy duty flex-pack applicator guns for 400ml or 600ml sausages.

- TOO C08-00121 600ml
- TOO C08-00125 400ml
- TOO C09-P00016A Blue sachet plunger
- TOO C09-P04059 Green high viscosity bulk materials plunger, 2/pkg



Nicopress Sleeve Crimping Tool

An economical crimping/swaging tool which will crimp copper oval sleeves for wire sizes 1/16", 3/32", 1/8", 5/32", 3/16".

Jaws are not adjustable.
• Length overall: 25-1/2"

LOO HSC-600



Sherman Johnson Crimping Tool

This tool crimps lifeline fittings onto either 1/8" or 3/16" stainless steel wire rope.

JHD 53-210



Blind Rivet Gun

Professional service blind riveter. Sturdy, fast acting tool. Will set 3/32", 1/8", 5/32", and 3/16" dia. rivets. (Max. 3/16 aluminum). Moulded centre hand grips and long handles for extra leverage. Complete with four nose pieces.

TOO 239-501



C.S. Osborne Caulking Irons

American made, malleable iron in sizes suiting light planking to heavy decking.

Part #	L x W	Blade
OSE 273-00	5" x 2"	1/32"
OSE 273-0	5-5/8" x 2-1/2"	1/16"
OSE 273-1	5-7/8" x 2-1/4"	1/8"



C.S. Osborne Ship Scraper

Well sharpened, 1/4" x 1" stock, made to conform to government specifications. 15" long with 1-3/4" wide blades for removal of heavy growth.

OSE 388



Taylor Ring Pliers

Specially made to grip clinching rings for 3/16" to 1/2" diameter. Spring loaded handles to hold ring until clamped on.

Overall length 6-7/8".

TAY 1046



Richard Professional Quality Putty Knives

The blade is ground and polished to exact requirements. Black handle is made of superior plastic and will not be affected by chemicals such as paint, thinners or other petroleum by-products. Available in a stiff or flexible blade.

RIC P-1-1/4-F	1-1/4" Flexible
RIC P-1-1/4-S	1-1/4" Stiff
RIC P-1-1/2-F	1-1/2" Flexible
RIC P-1-1/2-S	1-1/2" Stiff
RIC P-2-F	2" Flexible
RIC P-2-S	2" Stiff
RIC S-6-F	6" Flexible



Richard Pro Series Ergo Grip Putty Knives

These new Pro Series tools feature an exclusive Ergo Grip, rubber like handle, mated to the highly successful Pro Series blades.

Putty Knives

RIC RUB 1-1/4C	1-1/4" Chisel
RIC RUB 1-1/4S	1-1/4" Stiff
RIC RUB 1-1/4F	1-1/4" Flexible
RIC RUB 2F	2" Flexible
RIC RUB 2S	2" Stiff



Wall Scrapers

RIC RUB 3F	3" Flexible
RIC RUB 3S	3" Stiff



Paint Scrapers

RIC 04512	9" Handle
RIC 04514	14" Handle

Taping Knives

RIC RUB 114	4" Flexible
RIC RUB 115	5" Flexible
RIC RUB 116	6" Flexible



Razor Scraper

RIC RUB RS 300	Uses standard razor blade
-----------------------	---------------------------



Combination Tool

6 in 1 Combo tool - cleans paint rollers, cleans out cracks, opens cans, scrapes, sets nails, applies drywall compounds and spackle. 2-3/8" wide blade.

RIC RUB 119	
--------------------	--

Richard Putty Knives

These putty knives offer superior construction. The blades are made of half tang, spring steel which is heat treated and polished. The plastic handles feature a handy hanging hole. Available in a stiff or flexible blade.

RIC H-1-F	1" Flexible
RIC H-1-S	1" Stiff
RIC H-2-F	2" Flexible
RIC H-2-S	2" Stiff
RIC H-3-F	3" Flexible
RIC H-3-S	3" Stiff
RIC H-4-F	4" Flexible
RIC H-4-S	4" Stiff



Richard Wood Scrapers

Scraper blades are scientifically heat treated and tempered for longer cutting life. There is positively no vibration, blades have 2 cutting edges, and side angle points on blades make it easy to reach tight corners. A nut and bolt is used to hold blade in place. Plastic handle with handy hanging hole.



Part #	Blade Width	Handle Length	Replacement Blade
RIC W-10	1"	5-7/8"	RIC W-10-B
RIC W-1-3/4	1-3/4"	7-5/8"	RIC W-1-3/4-B
RIC W-2-1/2	2-1/2"	8-1/2"	RIC W-2-1/2-B
RIC W-14	2-1/2"	14"	RIC W-2-1/2-B

Western Pacific Trading Angle Scraper

Stainless steel angle scraper with a tapered 3" blade and heavy duty chemical resistant handle.

WPT 32040



Richard Drywall Knife

Pro-lite series, stainless steel blade with aluminum backer.

- Angled edge, full hard stainless steel blades - 0.018" thick
- Press punched aluminum backing
- Ergonomically designed painted polypropylene handles
- Applies and feathers drywall compound

RIC RW-12-AS	12"
---------------------	-----



Megapro Screwdriver

- Palm saving rotating cap
- Patented quick change bit system
- 7 double-ended bits, all are power tool interchangeable.
- 1 nut driver
- Stainless steel drive and high impact triax housing
- Rotating balance point collar
- 1/4" hex drive
- Lifetime replacement warranty against manufacturer's defects (bits excluded)



MTP 151SS Screwdriver

Replacement Bits:

MTP PD0-3S	Philips 0+3 Double ended bit.
MTP PD1-2S	Philips 1+2 Double ended bit
MTP SD0-3S	Square 0+3 Double ended bit
MTP SD1-2S	Square 1+2 Double ended bit
MTP TD10-15S	Torx 10+15 Double ended bit
MTP TD20-25S	Torx 20+25 Double ended bit
MTP FD4-6S	Flat 4+6 Double ended bit

PicQuic Six-Bit Screwdrivers

Picquic screwdrivers are the Original instant bit multi-drivers. Selecting one bit and storing the next is fast, easy and means virtually never losing a bit. Made in Canada with high grade materials and excellent craftsmanship. Bit selection covers all day to day jobs, at home or at work. The Sixpac is the perfect tool for any user and the Stubby is designed for work in tight quarters. The Mariner bits are electroless nickel plated for extra corrosion resistance, excellent choice for the boater. Bits included: Robertson: #1, #2, #3 Philips: #1, #2 Slotted: #6

PQT 88001	Regular
PQT 88002	Mariner
PQT 91002	Stubby



3" Power Bits

PQT 88010	#0 Robertson
PQT 88011	#1 Robertson
PQT 88012	#2 Robertson
PQT 88013	#3 Robertson
PQT 88021	#1 Philips
PQT 88022	#2 Philips
PQT 88023	#3 Philips
PQT 88131	3/16" Slotted
PQT 88114	1/4" Slotted
PQT 88215	T-15 Torx
PQT 88220	T-20 Torx
PQT 88225	T-25 Torx



Drive Bits

Assorted screwdriver bits provide safe, positive torque action. For machine driving, the two piece steel bits are exceptionally resistant to wear and breakage and precise sizing prevents slippage, work marring and damage to screw heads.

All pieces are 1/4" hex drive.

No.	Size	Description
FAS B140310	#0 x 1"	Robertson
FAS B140320	#0 x 2"	Robertson
MIB 375320	#0 x 4"	Robertson
FAS B140311	#1 x 1"	Robertson
FAS B140321	#1 x 2"	Robertson
FAS B140331	#1 x 3"	Robertson
FAS B140341	#1 x 4"	Robertson
FAS B140312	#2 x 1"	Robertson
FAS B140322	#2 x 2"	Robertson
FAS B140332	#2 x 3"	Robertson
FAS B140342	#2 x 4"	Robertson
FAS B140362	#2 x 6"	Robertson
FAS B140313	#3 x 1"	Robertson
FAS B140323	#3 x 2"	Robertson
FAS B140333	#3 x 3"	Robertson
MIB 375670	#3 x 4"	Robertson
MIB 376720	#3 x 6"	Robertson
FAS B140411	#1 x 1"	Philips
FAS B140421	#1 x 2"	Philips
FAS B140412	#2 x 1"	Philips
FAS B140424	#2 x 2"	Philips
FAS B140442	#2 x 4"	Philips
FAS B140462	#2 x 6"	Philips
FAS B140413	#3 x 1"	Philips
FAS B140423	#3 x 2"	Philips



Mibro High Speed Jobber Drill Bits

"HSS Super" high speed twist drill bits, full jobbers length, with straight shanks.

- MIB HSS-1/16" MIB HSS-19/64"
- MIB HSS-5/64" MIB HSS-5/16"
- MIB HSS-3/32" MIB HSS-21/64"
- MIB HSS-7/64" MIB HSS-11/32"
- MIB HSS-1/8" MIB HSS-23/64"
- MIB HSS-9/64" MIB HSS-3/8"
- MIB HSS-5/32" MIB HSS-25/64"
- MIB HSS-11/64" MIB HSS-13/32"
- MIB HSS-3/16" MIB HSS-27/64"
- MIB HSS-13/64" MIB HSS-7/16"
- MIB HSS-7/32" MIB HSS29/64"
- MIB HSS-15/64" MIB HSS-15/32"
- MIB HSS-1/4" MIB HSS-31/64"
- MIB HSS-17/64" MIB HSS-1/2"
- MIB HSS-9/32"



Mibro High Speed Prentice Drill Bits

H.S. blacksmith drill bits. Total length 6".

Part #	Size	Shank
MIB 270221	9/16"	3/8"



W.L. Fuller Taper Point Drill Bits

High speed steel drill bits in regular lengths. Taper points cut wood or plastics in one operation to provide for screw thread and shank. Will fit W.L. Fuller counter sinks.

- WLF TP1/8"
- WLF TP9/64"
- WLF TP11/64"
- WLF TP3/16"
- WLF TP13/64"
- WLF TP7/32"
- WLF TP1/4"



W.L. Fuller Countersinks

Suitable for straight or taper point drills these counter sinks will also counter bore for wood plug over screw head if desired. Can be matched for #6 thru #10 screw heads on drills for soft or hard woods. Will also cut plastics. Taper bit sold separately.

Part No.	Countersink Dia. x Drill Size
WLF C-3	1/4" x 3/32"
WLF C4	5/16" x 7/64"
WLF C44	5/16" x 1/8"
WLF C-65	5/16" x 9/64"
WLF C5	3/8" x 1/8"
WLF C6	3/8" x 9/64"
WLF C8	3/8" x 11/64"
WLF C9	3/8" x 3/16"
WLF C10	7/16" x 13/64"
WLF C12	1/2" x 7/32"
WLF C14	1/2" x 1/4"



W.L. Fuller Stop Collars

Designed to control depth of countersink hole.

- WLF SC3/8" To fit C5, 6, 7, 8, 9
- WLF SC1/2" To fit C12, 14



W.L. Fuller Plug Cutters

Designed for clean cutting and hardened for long life. These four blade plug cutters do not eject the plugs. The plug remains in the board and can be broken out with a screwdriver or the board can be sawed to free the plug.

Plugs are smooth and chamfered for easy starting.

Part No.	Plug Size x Shank Dia.
WLF PC-1/4"	1/4" x 1/4"
WLF PC-1/4" T	1/4" x 1/4" Tapered
WLF PC-5/16"	5/16" x 1/4"
WLF PC3/8"	3/8" x 3/8"
WLF PC3/8" T	3/8" x 1/4" Tapered
WLF PC1/2"	1/2" x 3/8"
WLF PC1/2" T	1/2" x 1/4" Tapered



Remington Grit Edge Saber Saw Blade

Thousands of super hard tungsten carbide particles are permanently, metallurgically bonded to strong alloy steel. These blades cut materials most other blades can't even scratch. No teeth to dull or strip. Works best on fibreglass. Designed for difficult to cut materials only. Do not use on soft woods, aluminum, or materials easily cut with regular blades. Shank: 1/4" Length: 3"



TOO GJ6BL

Head for the horizon with Dometic® marine toilet systems.



VacuFlush 4800 series toilets with electric, push-button flushing.

VacuFlush[®] TECHNOLOGY

- Quiet and easy to operate
- No odours
- Uses less water
- Easy to maintain



VacuFlush 5000 series toilets with foot-pedal flushing.

QUIETER AND MORE POWERFUL THAN EVER

Creating a powerful vacuum force that instantly clears the toilet bowl, the VacuFlush® J series vacuum generator is now 50% quieter than previous models. As a result, VacuFlush toilet systems make less noise than even the most popular macerating toilets – and make boating more pleasurable.



SeaLand® convenience products, including SaniGard™ vent filters, assure odor-free, trouble-free sanitation system performance. For complete, reliable toilet system service, rely on Dometic Sanitation.

Dometic

THE SIGN OF COMFORT