Seating	880 - 886
----------------	------------------

Seat Swivels, Sliders & Bases	887 - 893
--	------------------

Tables & Table Bases	893 - 895
---------------------------------	------------------

Deck Chairs	895
--------------------	------------

Bentley's Seats

Structures are made primarily of high grade 5/8-inch and 3/4-inch, 7-ply treated plywood. We use Naugahyde brand upholstery vinyl, resilient high-density foam rubber, wrapped in a protective covering, stainless steel bolts and stainless steel staples. All tops are made primarily with premium-grade marine vinyls, 7/8-inch O.D. Anodized aluminum or stainless frames, durable nylon or stainless fittings, corrosion resistant fasteners and snaps. Each top or cover is custom made to your specification. Please ask for colour choices.

Bentley's Mariner Chair

- Knee action mechanical suspension
- Heavy duty shock absorber
- 6" fore and aft double locking slide adjustment
- Fold up armrests
- Contoured lumbar support
- Convenient side chart pockets
- Custom upholstery (choose from an array of custom vinyl colours)
- For persons under 250 pounds
- Custom embroidered logos available on request

BSP MARINER* Chair

Options:

BSP SWIVEL-HD Swivel

- Heavy duty swivel base with 90° positioned locks

*Request Item

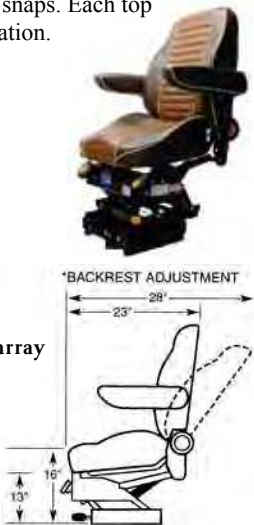

Bentley's Magnum Chair

The Magnum has standard features that out perform the competition.

Standard features include:

- Our famous fold-up armrest
- Covered in ballistic nylon that has tremendous wearability and great resistance to chafe and puncture
- High density foam for longtime comfort
- Deeper cushion for excellent support for the high mounted seat
- High back rest with headrest and lumbar support
- Available in black only

BSP MAGNUM-SMALL



Bentley's RiverMaster Chairs

The Rivermaster features plush armrests, a lower lumbar support and a high back rest for maximum comfort. The solid back rest is supported by a sturdy cast aluminum bracket. This seat comes standard with a map pocket behind the back rest.

BSP RIVERMST-SM* 26" W x 25" D x 24" H

BSP RIVERMST-LG* 28" W x 25" D x 24" H

BSP RMS-GRAPHITE 26" W x 25" D x 24" H

BSP RMS-SURF 26" W x 25" D x 24" H

*Request Item



Bentley's First Mate Chairs

This seat features a medium height solid back rest supported by a sturdy cast aluminum bracket system. Its design is an excellent combination of quality, comfort and economy.

BSP FIRSTMATE-SM* 26" W x 25" D x 22" H

BSP FIRSTMATE-LG* 28" W x 25" D x 22" H

*Request Item



Bentley's Guide Master Chairs

The Guide seat also features a solid back rest supported by a cast aluminum bracket. This seat comes standard with a map pocket and is available in two widths.

BSP GUIDE-SM* 26" W x 24" D x 21" H

BSP GUIDE-LG* 28" W x 24" D x 21" H

*Request Item



Bentley's Stationary Back to Back Seat

The stationary back rest design of this seat yields considerable strength to the structure allowing you to sit on top of the back rest without concern for damage to the seat.

The cushions are hinged for easy access to the storage area. Comes standard with bases and mounting hardware. Base height yields 12" from the floor to the seat cushion surface.

- 25"H x 19"W x 43"D

BSP STATIONARY-SM*

*Request Item



Bentley's Seats Colour Selection



TEMPRESS MARINE GROUP

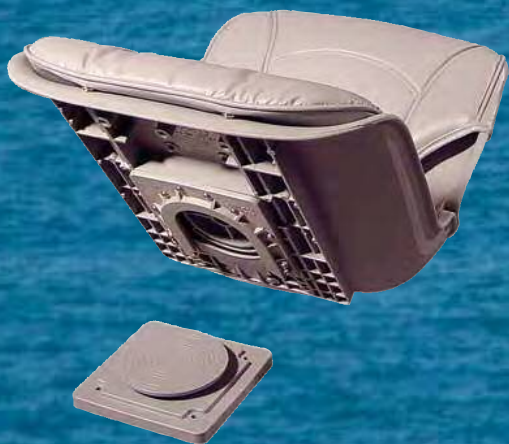

Marine Seating

Our goal is to continuously design and develop innovative problem solving products for the recreational marine, fishing and outdoor enthusiast.



Marine Storage

Better Products = Better Boating

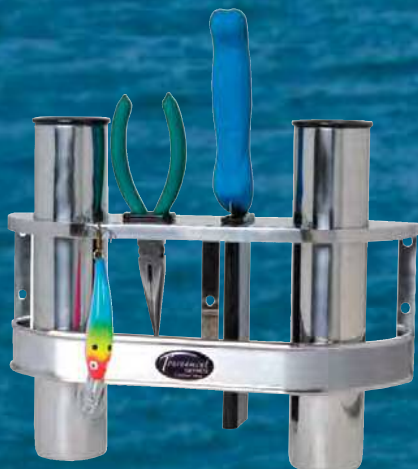

Angler's Gear

www.tempress.com

Tempress Profile Deluxe Seat

The Profile Deluxe includes a thickly padded deluxe cushion. The foam pack is upgraded in thickness and contouring to provide maximum comfort made from high-density marine foam and wrapped with 30 oz marine grade UV stable vinyl. Additional features include the "no-pinch" hinge shell design with a built in lock that automatically engages when the seat is folded down.



The seat mounts to any standard marine swivel, slide or spider.

- H: 18" x W: 19" x D: 18-1/2"

TMP 60181 Charcoal/grey

Tempress Profile Seat

The Profile features a double contoured seat pan that eliminates pressure points. There is also a built in lock that automatically engages when the seat is folded down, preventing unwanted blow up of the seat back when trailering or running. Stainless steel hinge pins secure the fold down back and included 1/4" x 20 t-nuts allow mounting to any standard marine swivel, slide, or seat spider. Will accept the Quick Disconnect Mounting Kit. Cushion is made with 30oz marine grade UV stable vinyl, and filled with high density marine foam.



TMP 48600 White/grey

Tempress Navistyle High-Back Seats



Subtle curves provide lumbar support while the tapered sides allow for the lateral movements desired by active users. The Navistyle also features our exclusive "no-pinch" hinge, with automatic locking mechanism that secures the seat in the folded position. All Tempress Seats will mount to any seat swivel or slide with the built in stainless steel T-nuts, and included stainless steel mounting hardware.

- 21-3/4" H x 18" W x 19-1/2" D

TMP 54800 White
TMP 54901 Grey/blue
TMP 54907 Charcoal/grey

Tempress Elite Helm Seats

Rotationally molded helm seat that incorporates the patented NaviStyle StylePanel system and is constructed of materials designed to withstand the rigours of the marine environment. The contoured StylePanels create a comfortable seating surface that is ergonomically correct without the excessive use of foam. Built in lumbar support and a rolled front edge make the New Tempress Helm Seat perfect for any application in which comfort, durability, and superior style are desired.



High Back

- H: 26" x W: 23.5" x D:27.5"
- White shell / White cushions

TMP 57010

- Charcoal shell / Grey cushions

TMP 57017

Low Back

- H: 22" x W: 23.5" x D:27.5"
- Charcoal shell / Grey cushions

TMP 57027

Tempress Reflex DST Seats

Dual shock technology delivers two levels of shock absorption. The seating surface contains a suspended Dymetrol* trampoline surface to provide stationary seating comfort, plus twin spring-loaded shock absorbers beneath the seat pan for extreme shock control in rough conditions. Also featured is the ergonomic lumbar support, side bolsters and thigh support for long trips offshore. A padded headrest provides additional comfort. The frame design features a flow-through back for ventilation and a built-in spring loaded lock for both the folded and upright positions.



- Dimensions: 31"H x 21"W x 22"D

TMP 58055 Charcoal/grey

TMP 58075 White/blue

*DuPont Dymetrol high-performance fabrics provide strong, stretchable suspension materials for today's demanding auto, aircraft, and furniture seating.

Eagle Craft Wave Rider Seat

This is a commercial and yacht quality seat that is designed to last for years of service. Deluxe all-weather arms and seating. Solid cast aluminum frames. Injection moulded plastic back and seat base. Heavy wearing Enduratex seat covering.

- Blue

WAV 330027



Garelick "Quality" Boat Seats



Full 16" width bucket style offers fully cushioned comfort at an affordable price. Top quality components – marine grade vinyl, high density foam, durable treated plywood, sturdy folding aluminum hinges, stainless steel staples, plastic corner guards, double stitched Dacron thread, heavy vinyl tie down strap.

- 16"W x 15"D x 18"H

GAR 48391-1	White
GAR 48391-2	Blue
GAR 48391-9	Grey

Garelick Citation Premium Fold Down Seats



Two-colour up-scale 30oz. marine grade vinyl with UV inhibitor, superior abrasion resistance and finish to resist dirt and grime. Dual Durometer High Density foam for lasting comfort. Contour styling for greater thigh and back support. Molded plastic seat and back.

GAR 48691-1	White/Silver
GAR 48691-2	Blue/Silver
GAR 48691-9	Grey/Silver
GAR 48691-15	Ivory/Gold

Garelick Multi-Purpose Utility Seat

Anodized aluminium frame. Molded seamless vinyl cushions and arms with waterproof foam padding. No seams to split. Molded seamless cushions are ideal for outdoor applications. White.

- 24"W x 19"D x 17-1/2"H

GAR 48103-1



Garelick Deluxe Sewn Seat

Extra large sewn cushions. Seat cushion is 4" thick and 5-1/2" wings make up attractive bucket appearance. Sewn with Dacron thread. Weather and mildew resistant marine vinyl material. Tough anodized aluminum extrusions are used for back and arm supports. Sewn seats are not recommended for outside applications.

- 25-1/2"W x 20"D x 19-1/2"H

GAR 48251-1 White



Garelick Commercial Duty Bucket Seats

Large comfortable cushions. Molded seamless construction. Waterproof foam padding. Tough anodized aluminium extrusions are used for back and arm supports.

- 25-1/4" W x 19-1/2" D x 20" H

GAR 48061-1	White
GAR 48061-7	Black



Garelick "Ultimate" Multi-Purpose Seat

Ideal for flybridge, helm station or fishing. All weather white polymer seat, support frame with classic ladder design back rest. Made for easy maintenance. Resists harsh sun and sea conditions, including ultraviolet light. Thick, luxurious, removable white cushions snap to frame for rich added comfort.

Frame is thru-bolted together with tough anodized aluminum extrusions and all stainless steel hardware fasteners. Matching 1-piece armrests add comfort. Compatible with Garelick pedestal bases, swivels, chair stands and slides.

- 26-1/2" W x 17-1/2" D x 20" H

GAR 48450-1



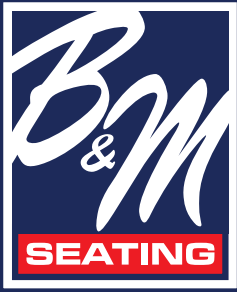

PREMIUM MARINE SEATING

FISHING CHAIRS

- Extra-heavy duty, 28 oz. marine-grade vinyl
- State-of-the-art, high-impact plastic frames
- High density foam padding
- Plastic sealed to resist moisture
- Mildew-resistant & UV treated to prevent fading

BM734

LOW BACK SEATS

Height: 18-1/2" Width: 16" Depth: 16"

BM734-715 Sand

BM734-717 Grey

BM734-718 Light Blue

BM781

HIGH BACK SEATS

Height: 22" Width: 16-1/2" Depth: 18"

BM781-660 Grey/Navy

BM781-661 Grey/Red

BM781-662 Sand/Brown

BM781-664 Grey/Charcoal

DELUXE LOUNGE SEATS

- Extra-heavy duty, 28 oz. marine-grade vinyl
- State-of-the-art, high-impact plastic frames
- Molded plastic bases are scuff and mar resistant
- High density foam padding
- Plastic sealed to resist moisture
- Mildew-resistant & UV treated to prevent fading

68FR

DELUXE LOUNGE SEAT

Seat Height: 27-1/2" Width: 18" Reclined: 66"
Base Height: 10" Width: 13-1/2" Length: 36-1/4"

BM68FR-204 White

BM68FR-208 Navy

BM68FR-221 Grey

79FR10

DELUXE LOUNGE SEAT

Seat Height: 27-1/2" Width: 19" Reclined: 65"
Base Height: 10" Width: 13-1/2" Length: 36-1/4"

BM79FR10-204 White

BM79FR10-208 Navy

BM79FR10-221 Grey



715
Sand

717
Grey

718
Light Blue

BM734



BM781



660
Grey
Navy

661
Grey
Red

662
Sand
Brown

664
Grey
Charcoal

68FR



204
White

208
Navy

221
Grey



79FR10



204
White

208
Navy

221
Grey

B&M Seating Low Back Seats

- High impact plastic frame
- Compression foam padding
- Plastic sealed to resist moisture
- Heavy duty 28 oz. marine grade vinyl
- UV treated to resist mildew and fading
- H: 18-1/2" x W: 16" x D: 16"
- 6" swivel

B&M BM734-715 Sand
B&M BM734-717 Grey
B&M BM734-718 Light blue

B&M Seating High Back Seats

- High impact plastic frame
- Compression foam padding
- Plastic sealed to resist moisture
- Heavy duty 28 oz. marine grade vinyl
- UV treated to resist mildew and fading
- H: 22" x W: 16-1/2" x D: 18"

B&M BM781PLS-660 Grey/blue
B&M BM781PLS-661 Grey/red
B&M BM781PLS-662 Sand/brown
B&M BM781PLS-664 Grey/charcoal

**B&M Seating
Extra Wide Captain's Chair**

Extra wide captain's chair manufactured from high-impact plastic.

- H: 21" x W: 23-1/2" x D: 24"

B&M BM1007-1

**B&M Seating
Chair/Slide Pedestal Package**

- UV stabilized polyethylene
- Snap on cushions
- UV treated & mildew resistant
- Seat Dim: H: 19" x W: 20.5" x D: 18"
- Pedestal height: 15"
- Slider travel: 5"

B&M BM015-710

**Garelick Rotational Molded Seat**

A beautiful weatherproof white shell. Designed with a high supportive back, and a deep wide contoured seat. Comes with white removable cushions. Compatible with most pedestals, seat slides and rockers.

- 20"W x 23"D x 19"H

GAR 48400-1 White

**Garelick Value Seat Package**

This complete package is ideal for new installations or seat replacement. Package includes a molded polyethylene white seat, marine grade white snap-on cushions and a 15" anodized aluminum pedestal base.

- 20"W x 23"D x 19"H

GAR 48406

**Springfield Skippers Chair Seat Package**

Contemporary injection molded fold down seat features clean lines that create a modern look and feel. Interlocking hinge design offers a great structural support and fit. Comes with universal bolt pattern to accommodate most mounting applications.

- Comes with adjustable belle pedestal
- Complete with cushions

SPR 1001004

**B&M Seating Boat Seat**

Plastic fold-down boat seat comes with grey/charcoal vinyl cushions.

- Comes with a 6" zinc plated swivel
- W: 20" x H: 15" x D: 17"

B&M 353C-221/213

**Attwood Pro-Form Boat Seat**

Ergonomic design. Exclusive seat lock. Pinch resistant hinge. Comes in an attractive display box. Accepts any 7" swivel. Light grey with upholstered grey cushions.

- 19.25"W x 18.25"D x 16.75"H

ATT 7012-504-4



Tempress Low Back All Weather Seat Shells w/ T-Nuts

All-Weather features a double contoured seat pan that eliminates pressure points. Stainless Steel hinge pins secure the fold down back and included 1/4" x 20 t-nuts allow mounting to any standard marine swivel, slide, or seat spider. The All-Weather seat shell will also accept the quick disconnect mounting kit.

- Dimensions: 16-1/2"H x 18-1/4"W x 17"D

TMP 45040 White

TMP 45043 Grey



Tempress All-Weather Cushions

All-weather cushions tailored to fit Tempress seats. Cushions eliminate the discomfort of all-day cruising or fishing. High-density, resilient, urethane foam covered with top grade, marine vinyl that is mildew, abrasion and stain resistant. Snap-on cushions are easily removable for maintenance or storage.

TMP 54030 Grey

TMP 54035 White



54030 Shown with seat

Tempress Quick Disconnect Seats

Designed specifically for the fisherman who wants comfort and convenience of a removable seat. Features a positive lock quick disconnect feature allowing installation and removal of seat easily.

- 16-1/2"H x 18-1/4"W x 17"D

TMP 45130 Seat only-White

TMP 45133 Seat only-Grey

TMP 45150 Seat & Cushions-White

TMP 45153 Seat & Cushions-Grey



Quick Disconnect - Mount Only

TMP 45830 White

TMP 45833 Grey

Quick Disconnect Retrofit Kits

The kit includes the mount, adapter plate for the seat bottom, and the locking plate.

- Hardware included

TMP 45930 White

TMP 45933 Grey

B&M Seating Deluxe Lounger Seats



- Extra heavy duty 28 oz marine grade vinyl
- Molded plastic bases are scuff and mar resistant
- High density foam padding
- UV treated & mildew resistant
- Plastic sealed to resist moisture

- Seat Height: 27-1/2" x W: 18" x Reclined: 66"
- Base Height: 10" x W: 13-1/2" x L: 36-1/4"

B&M 68FR-204 White

B&M 68FR-208 Navy

B&M 68FR-221 Grey



- Seat Height: 27-1/2" x W: 19" x Reclined: 65"
- Base Height: 10" x W: 13-1/2" x L: 36-1/4"

B&M 79FR10-204 White

B&M 79FR10-208 Navy

B&M 79FR10-221 Grey

B&M Seating Livewell Cooler Seat

- Stainless steel arms
- Extra heavy duty 28 oz marine grade vinyl
- Molded plastic bases are scuff and mar resistant
- High density foam padding
- UV treated & mildew resistant
- Plastic sealed to resist moisture
- Height: 35" x W: 33" x D: 18-1/2"

B&M BM437SS-710 White



B&M Seat Swivel

- Powder coated steel
- 360° swivel
- 5-1/4" hole pattern
- 6" square

B&M 613**B&M Quick Disconnects Seat Mounts**

- Durable molded plastic
- Steel rail frame
- Stainless steel spring

B&M BM16 For 7" swivel**B&M BM17** For 6" swivel**B&M Seat Clamp**

- Adjustable boat seat clamp
- Adjusts from 8" to 19"
- Comes with zinc plated swivel

B&M 819JBC**B&M Seat Clamp**

- Adjustable boat seat clamp
- Adjusts from 8" to 19"

B&M BM80**B&M Fore & Aft Seat Slide**

- Anodized aluminum with a 2-7/8" seat mount
- Fits locking & non-locking 2-7/8" pedestals
- Slide plates fits most seats

B&M BM374**B&M Universal Mounting Plate**

- 4 x 1/2" pre-drilled & 4 x 1/4" counter sunk holes
- Polyethylene construction
- Fits most marine seats and hardware

B&M BM399-1**B&M Pedestals**

- 7" or 13" black painted steel pedestals
- Base dim: 6-7/8" x 6-7/8"

B&M BM700 7"**B&M BM1300** 13"**Garelick Seat Swivels**

360° self-lubricated poly ball bearing swivel, heavily plated to resist corrosion. 6" square.

GAR 75016**GAR 75017** With 7° angle**Easy Mount Swivel**

As No. 75016 except larger bottom half, allows easy mounting from the top side.

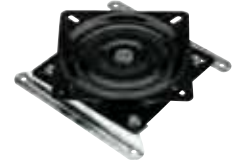
GAR 75018**Removable Seat Swivel**

Quick release mechanism allows seat to be easily removed. Sturdy plastic tracks mount permanently to boat. Swivel slides in between track and locks in place. Lever allows easy detachment of swivel and seat.

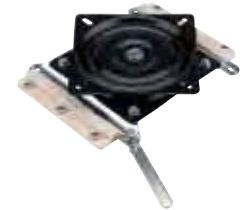
GAR 75019**Garelick Heavy Duty Ball Bearing Seat Swivels**

For marine and outdoor use. Choice of stainless steel or steel with a zinc finish comes with 12 ball bearings. 7" square top and bottom plates on 5-1/4" centre slots.

GAR 712-12BB Zinc**GAR 75020** 304 stainless steel**Garelick Clamp-On Seat Swivel**

- Accepts standard boat seats and fits tank or bench tops
- All metal design
- Quick mounting and dismount
- 360° swivel
- Vinyl covered clamps
- Adjusts from 8" to 18"
- Plate dimensions: 6" x 6"

GAR 75007

Garelick Seat Shock Absorber System

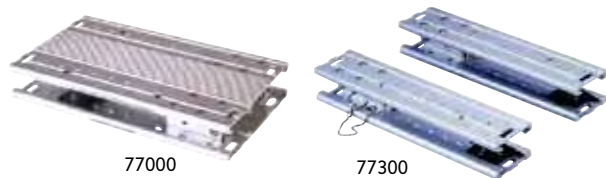

Helps to cushion the impact of uncomfortable and constant wave pounding caused by rough water. Now boat passengers can enjoy a smoother ride and minimize feelings of nausea and seasickness in all types of weather conditions and open water.

- Absorbs up to 75% of the shock, jolt and vibration transmitted to passengers from the forces of roll, pitch and yaw
- Adjustable compression allows for maximum comfort
- Compact size and low profile design adds only 2" of height
- Easily mounts to almost any current seat or slide available
- Rugged, high tensile anodized aluminum and stainless steel hardware construction

Pedestal Base Mount

- Heavy duty forward hinge allows shock absorption to occur in the vertical plane only, thus eliminating unnecessary side sway
- Standard bolt hole pattern allows for mounting on top of pedestal and beneath individual seat

GAR 77000

Floor & Deck Mount

- Independent rail suspension unit
- Standard bolt hole pattern allows for easy mounting beneath seat to the deck, a box or the floor of a boat
- Perfect for mounting beneath seat greater than 20"

GAR 77300

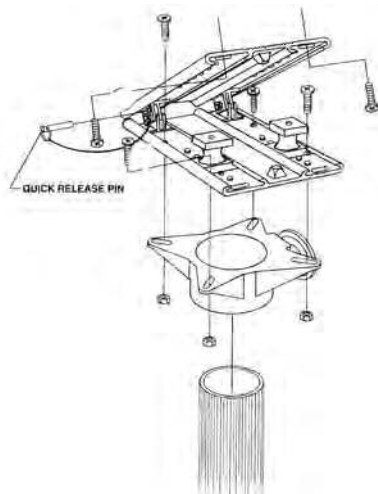

Swivel-Eze Seat Rocker

Add comfort to your cruising. All new tempered aluminum seat spring absorbs shock and moves the luxury level up one notch. Fits all 5-1/4" standard hole patterns.

SWI 1570



Garelick Low Profile Seat Slide

Common Features

- Allows helm or boat seats to adjust fore and aft
- Slide mounts under seat in between seat and pedestal base
- Convenient handle provides solid locking at any position
- Compatible with most 360° spiders
- Wobble-free design/operation
- Anodized aluminum with stainless steel hardware

75091 : Full Length Size for roto-molded seats.

For low profile installations where slide mounts directly to deck.

- 7" (18cm) fore and aft travel
- 8.5" W x 13" L x 1.63" H
- Lock handle is angled upward



GAR 75091

75081 : Full Length Size for roto-molded seats.

For use on any seat needing reinforcement underneath.

- 7" (18cm) fore and aft travel
- 8.5" W x 13" L x 1.63" H
- Required on all Roto molded seats

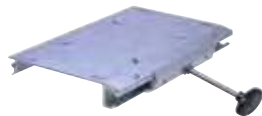

GAR 75081

75080 : Standard Size for wood or plastic seats.

- 6" (15cm) fore and aft travel
- 8.5" W x 8" L x 1.63" H



GAR 75080

Spare parts:

GAR 06.388 Locking Handle 6"

Garelick Low Profile Locking Seat Swivel

- Fits standard seat hole pattern (5-5/8" - 6" centre)
- Convenient handle provides solid lock at any position
- 8 position locking swivel, locks in at 45° increments or free swivels
- Anodized aluminum for added protection from saltwater corrosion
- 8.5" W x 8" L x 4" W



GAR 75096

Garelick Reinforcement Plate

For roto molded seats when a fore and aft seat slide is not used. Accepts 99023, 99025, 99026 and 99036 swivels.

- 13" x 7-3/4" x 3/16"
- Mounting holes 12-1/2" x 5"



GAR 99070

Garelick Anodized Spider Top

- 4 prong spider swivels 360° and locks
- Fits most 2-7/8" dia stanchion bases

GAR 99023 Fluted/Smooth

Spare Parts:

GAR 99028 Bearing cup for 99023

**Garelick 360° Swivel Positive Seat Mount Tops**

- Provides full circle rotation for seating
- Secondary twist control drag affords selected drag for rotation
- Internal delrin bearing cup engages in 10° increments for positive lock when tightening
- Dual quick lock handles –lever actuated, provides stable wobble free support; positive lock engages immediately
- Fits most 2-7/8" dia stanchion bases
- Meets ABYC-H31, Type A seating standards

GAR 99026 Fluted

GAR 99036 Smooth

Spare Parts:

GAR 99027 Bearing cup for 99025/26

GAR 99127 Bearing cup for 99036/22000

**Garelick Combination Seat Slide & Swivel Spider**

- Fore & aft travel, 360° seat rotation
- Wobble free design
- Compatible with any 2-7/8" dia tube
- Convenient handles provide solid locking at any position

GAR 75083 Fluted/Smooth

**Garelick Millennium 2000 Seat Slide Systems**

- Smooth fore and aft travel and 360° seat rotation
- Compatible with 2-7/8" dia tube
- Smooth positive lock action slide –convenient spring loaded lock and release lever (left or right)
- Secondary twist control drag handle affords selective drag for rotation
- Positive quick lock engages immediately

GAR 21000 Fluted, left

GAR 22000 Smooth, left

GAR 22001 Smooth, right

**Garelick Fixed Height Pedestals**

- Solid base support for a variety of seat hardware
- Mounts fore and aft seat slides and 360° spider combinations

GAR 75431 9" Smooth

GAR 75430 12" Smooth

GAR 75415 15" Smooth

GAR 75432 18" Smooth

GAR 75433 24" Smooth

GAR 75434 30" Smooth

GAR 75531 9" Fluted

GAR 75530 12" Fluted

GAR 75515 15" Fluted

GAR 75532 18" Fluted

GAR 75533 24" Fluted

GAR 75534 30" Fluted

**Garelick Adjustable Height Seat Bases**

- Standard Friction Lock
- Seat rises and lowers, locking in at desired height
- 2-7/8" dia. stanchion tube, 9" dia. base plate
- Anodized protective finish helps prevent saltwater corrosion and weathering.

GAR 75436 12" - 17" Smooth

GAR 75437 18" - 24" Smooth

GAR 75535 12" - 18" Fluted

GAR 75528 18" - 24" Fluted

**Garelick Blue Water Adjustable Height Seat Bases**

- Positive Pin Type Lock
- Pin secures base at specific 1" increments
- Stainless steel locking pin locates securing hole easily
- Anodized protective finish helps prevent saltwater corrosion and weathering

GAR 75438 12" - 17" Smooth

GAR 75628 18" - 24" Fluted

GAR 75635 12" - 17" Fluted

**Garelick Blue Water Adjustable Seat Bases**

Stainless steel lock pin secures to base in 1" increments. Positive lock spider rotates 360°. Fluted bearing cup fits into matching ribbed stanchion profile.

GAR 75435 12" - 17"

GAR 75428 18" - 24"



Garelick Gas Rise Pedestals

- Touch activated lever, gas rise
- High tensile aluminum construction
- Precision fit, no wobble 2-7/8" dia. pedestal base with Millennium Slide and Swivel

GAR 75636 Low 12" - 15"
GAR 75637 Medium 14" - 18"



Garelick Yacht Seating System

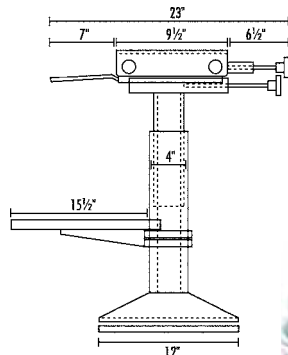

Designed for boats 30' and larger. Integrated 360° swivel rotation, fore and aft. slide and gas spring lift features are standard. 12" dia. base casting with 6-3/8" mounting holes in 60° increments for installation.

Swivel – 360° free rotation or positive lock in 45° increments – single lever operation is drag adjustable for maximum performance.

Slide – 6" of fore & aft travel with positive locking 1" increments. Solid 1" stainless steel slide rails are operated with a single lever for effortless and smooth operation.

Lift – vertical travel of 4" is operated from a single lever in lift to lift motion. A gas spring and lubrication system provide 112 lbs. of lift.

GAR 78218* 14" - 18" adjustable pedestal
GAR 78225 21" - 25" adjustable pedestal
GAR 78350 Foot rest 17-1/8" W x 15-1/2" L x 1" thick

* Request Items

Garelick Detachable Stanchion Plate

- Plate mounts to deck surface for base attachment
- Allows base and seat to be removed
- 9.25" (23 cm) diameter machined anodized aluminum, 3 stainless cap screws, and allen wrench included
- Adapts to all models, simply enlarge 6 base holes to 7/16" diameter
- Adds reinforced safety and comfort to pedestal installations

GAR 75056



Garelick Foot Rest/Cockpit Steps

Heavy duty wrap around aluminum extrusion with brushed anodized aluminum finish. Use with helm seats as a foot rest or as a boarding step mounted inside the coaming.

- 7-1/2" H x 15" W x 8-1/4" D

GAR 27415 White polymer step
GAR 27515 Teak step



Garelick Foot Rest/Cockpit Step

Heavy duty wrap around aluminum extrusion with brushed anodized aluminum finish. 4 Positions provides 5" of vertical height adjustment. Angled 18° down for a comfortable foot rest position.

- 7-1/2" H x 15" W x 8-1/4" D

GAR 27516 Teak



Garelick Foot Rest/Cockpit Step

Used in conjunction with Helmsmen Seats for added comfort and safety. Eliminates dangling feet while piloting craft. Can be used as cockpit step when boarding. Sturdy aluminum stamping supports varnished traction grooved step. Folds up when not in use.

- 15" W x 7-1/2" H x 8-1/2" D

GAR 26015 Oak treads

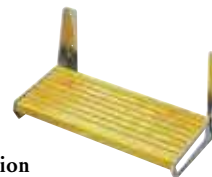

Garelick Swivel Stanchion Foot Rest

Solid aluminum casting. Fits on 2-7/8" stanchion. Adjusts for desired height. No slip strip surface provided for foot rest surface.

GAR 75004



Heavy Duty Anodized Seat Hinge

Classic style anodized aluminum seat hinge. Made to bolt through the base or plywood of seats.

HIN 1741



Garelick Seat Hinges

Classic style anodized aluminum. Made to bolt through the base or plywood of seats. Wood grain inserts. Sold in pairs.

GAR 75013

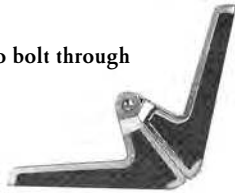

Garelick Seat Arm Extensions

- Anodized aluminum extrusion 2" x .5"
- Formed and drilled
- Sold in pairs

GAR 75051



Springfield Kingpin Seat Mount

For use with Kingpin posts and pedestals. Provides a full 360° rotation and 3-degree lean-back angle for optimum seating comfort. Made with heavily plated steel.

SPR 1615201-EC With spring



Springfield Kingpin Pedestal

A touch of the lever gives you nearly 7" of instant height adjustment, from 16" to 22-3/4". Includes die-cast aluminum seat mount with black powder-coat protective finish. Rotates a full 360°. Power cylinder is protected by a stainless steel sleeve. Fits all Kingpin bases.

SPR 1611401-S



Springfield Kingpin "Hi-Lo" Series Pedestals

- Two position removable seat pedestals
- 1-3/4" diameter post and reinforcement ring
- 3/4" sockets
- Satin finish

SPR 1610411-S 11"

SPR 1610413-S 13"



Springfield Kingpin S/S Bases

For use with Kingpin posts and pedestals.

SPR 1620001 7" x 7"

SPR 1620004 6" x 8"



Springfield Taper Lock "Hi-Lo" Pedestal

This form of pedestal allows for easy removal from its base yet remains firmly in place when required.

- Tapered Delrin post bushing
- 2" dia. Taper-Lock post
- Lo: 4" from deck to top of seat mount
- Hi: 18" from boat deck to top of seat mount

SPR 1600427

ABYC and H-31 Rated Class B:

Seat designed for occupancy only at boat speeds not exceeding five miles per hour.



Springfield Taper-Lock Power Rise Pedestal

Allows for easy removal from its base yet remains firmly in place when required.

- 2" dia. Taper-Lock post
- Trac-Lock III swivel seat mount w/locking handle
- Down: 13" from deck to top of seat mount
- Up: 19-1/2" from boat deck to top of seat mount

SPR 1601011

ABYC and H-31 Rated Class B:
Seat designed for occupancy only at boat speeds not exceeding five miles per hour.



Springfield Taper-Lock Pedestal

Allows for easy removal from its base yet remains firmly in place when required.

- 2" dia. Taper-Lock post
- Trac-Lock III swivel seat mount w/locking handle
- 11-3/4" from boat deck to top of seat mount

SPR 1600635

ABYC and H-31 Rated: Class A Passenger
Seat mount must resist 30 foot pounds of torque



Springfield Taper-Lock Bases

- For use with Taper-Lock pedestals. Made of aluminum with a satin finish. Dia 9"

SPR 1600003 Flush mount
SPR 1600010 Surface mount



Springfield Spring Lock Base

Made with superior strength. Will accommodate most 1.77" dia pedestals. 9" round. Aluminum.

SPR 1640002



Springfield Quad Action Swivels

Built from high strength aluminium, stainless steel hardware and engineering grade plastics.

SPR 1100021-1 2-7/8" post
SPR 1100031-1 2-3/8" post

SPR 2171001 Replacement 2-7/8" bushing
SPR 2171000 Replacement 2-3/8" bushing



Springfield Trac-Loc III



Exceeds ABYC H-31 standard for Class AD or AP applications. This swivel and slide unit features an easy to reach front operating handle for both the fore/aft adjustments on the swivel.

SPR 1100521-1
SPR 2171001 Replacement bushing

Springfield Adjustable Seat Pedestal

- Uses a sealed gas powered cylinder to supply height adjustment to your helm seat
- Easy to reach handle
- Select height from 14-1/2"-19-1/2"
- Manufactured for saltwater use
- Anodized finish
- 9" base diameter
- 360° locking swivel

SPR 1250100

ABYC and H-31 Rated: Class A Passenger
Seat mount must resist 30 foot pounds of torque



Springfield Heavy Duty Mainstay Pedestal

- Power assisted adjustments from 15" to 20"
- Energy absorbing urethane mount between post and base
- Four rotational locking positions
- Rigid keyed aluminium extrusion design
- Convenient front operating handle for height adjustment
- Anodized for maximum corrosion protection
- Three year warranty

SPR 1250301 Hydraulic pedestal with slide

Parts:
SPR 2171006 Replacement slide pads

ABYC and H-31 Rated: Class A Passenger
Seat mount must resist 30 foot pounds of torque



TACO Seat Supports

Cast aluminum, powder coated silver, seat support allows for 360° rotation. Accepts non-tapered column. 9-7/16" square.



TAC Z20-3760PCS 2-3/8"
TAC Z20-3776PCS 3"

TACO Pedestal Base

Brite anodized aluminum surface mount base receives a tapered column.
 • OD: 3", Outside dia: 9-7/8"



TAC Z10-4070BLY76MM

TACO Pedestal Base

Powder coated cast aluminum 'Starfish' base provides for free movement. Receives a tapered column.
 • OD: 3", Outside dia.: 25"



TAC Z10-4030PCS

TACO Manual Seat Pedestals

Aluminum extruded columns allow for manual height adjustment. Features a tapered end to ensure a steady fit. Anodized for lasting protection.
 • Top OD: 2-3/8"
 • Bottom OD: 3". Dia.: 80 mm



TAC Z80-2070VEL 20-5/8" to 31-7/8"
TAC Z80-2080VEL 12-3/8" to 15-3/4"

TACO Power-Matic Seat Pedestals

Same features as above pedestals but with an internal gas cylinder to provide easy and smooth height adjustments.

TAC Z80-2510VEL 20-1/2" to 32-1/2"
TAC Z80-2515VEL 11-3/4" to 16"

TACO Seat Mounted Footrest

Silver powder coated 2-3/8" footrest. Versatile, fits 60 mm & 76 mm seat supports/columns.



TAC Z40-4195PCS60/76MM

ITC SurFit Table Legs and Bases

Optimum stability for removable tables is provided by the SurFit system. Tapered end cap is permanently affixed to the steel leg. The plastic cap is precision molded to the matching taper of the cast aluminum base creating the tightest fit of any system. The natural lubricity of the plastic makes insertion and removal a simple matter of twist in/twist out. All parts receive a "baked on" black corrosion and chip resistant powder coating.

No.	Description	Dia
ITC 81TL-27B	27" table leg	2"
ITC 81TR-1000B	Recessed base	6-1/2"
ITC 81TS-1000B	Surface base	6-1/2"



*Normal height for a table is 30". If using a recessed base, use the longer table leg. If using the surface mount base use the shorter table leg.

TACO Powermatic Table Pedestal

Gas charged cylinder raises the table at a turn of a knob. To lower simply turn knob to release and press down on table top.

Table support
 • 2-3/8" ID, 19-3/4" x 7-1/4"



TAC Z20-3160PCS

Power pedestal
 • 2-3/8" top x 3" bottom, 19" to 32" Range

TAC Z80-2190VEL

Base support
 • 3"ID, 9-7/8" Dia. base

TAC Z10-4070BLY76MM



Garelick Taper Socket Table Bases

Engineered for marine use.

These all aluminum components provide a solid table base that allows table to be removed quickly without tools. Features EEZ-In Taper Socket Design for wobble free use. Unique fluted profile stanchion tube has a protective anodized finish.



Part #	Description	Height	Diameter
GAR 75358	Short Tapered Post*	28-3/4"	2-7/8"
GAR 75357	Long Tapered Post*	30"	2-7/8"
GAR 75355	Flush base	N/A	9-1/4"
GAR 75356	Surface Mount base	N/A	9-1/4"

*Normal height for a table is 30". If using a recessed base, use the longer table leg. If using the surface mount base use the shorter table leg.

Garelick Adjustable Table Pedestal

Converts dinettes to berths. Adjusts to any position from 14-1/2" to 30-3/4". 2-7/8" stanchion tubing is welded to 9" diameter cast aluminum base at each end. In lower position inside tube goes below deck 6". Anodized.

GAR 75225



Garelick Table Pedestal

Fluted anodized finish. Pedestal descends 6" below deck level when fully retracted. Ideal for dinette/berth applications. Stable, no-wobble design.

- Height range: 14-1/2" to 30-3/4"

GAR 75325



Springfield Thread-Lock Table Pedestal

Allows for easy removal from its base yet remains firmly in place when required.

- No need to cut a hole with a deck mount base
- Base is a screw mount
- Post has a locking table mount assembly
- 20" to 26" adjustable height
- Polished aluminum finish

SPR 3692700



SEATING



75649



75650

Garelick Quick Release Table Pedestal Systems

- Quick release levers allows effortless take-down of table system for storage
- Deck ring mounts nearly flush with deck for minimal interference when table is stowed
- No need to drill large centre hole in deck as required with other table hardware systems
- Marine grade polymer components resist corrosion
- Stanchion post is 2-1/4" anodized aluminum w/ ribbed finish and tapered at both ends
- System height is 27" from deck surface to underside of table top

GAR 75640 Complete system includes: deck ring, socket base, table mounting socket, stanchion tube

GAR 75649 Includes complete system 75640 and round 20" (51 cm) diameter melamine table top

GAR 75650 Complete system includes 75640 and a 15" x 28" rectangular white polymer table top and two recessed cup holders



Socket mount

Garelick Side Mount Table System

Oval table top

- 18" x 30"
- Acrylic coated ABS plastic
- White colour
- 75648 table socket mounted to underside

GAR 75320-21 Table top

Curved, side mount table leg

- Bright finish anodized aluminum
- Stainless steel mounting bracket

GAR 75343-10 Leg & bracket

GAR 75402 S/S mounting bracket



Garelick Folding Deck Tables



- Polyethylene or melamine top tables with textured finish
- Aluminum legs with plastic tips

Part #	LxWxH	Material
GAR 50410-1	24" Diameter	Melamine
GAR 50400-1	24" x 16" x 16"	Melamine
GAR 50405-1	32" x 16" x 21.5"	Melamine

Garelick Side Mount Seat and Table Hardware

All aluminum support arms attach to bottom of helm seat or table and fit into brackets which attach to the side of the boat. H-Type stanchion leg fits into sockets mounted under seat or table. Allows the seat or table to be folded down against the bulkhead or coaming.



GAR 75055

Sea-Dog Table Brackets

- Stamped 304 stainless steel
- Two wall plates and two table brackets
- Table: W: 3-3/8" x H: 2-1/8"
- Wall: W: 1-3/4" x H: 2-3/4"



SED 221320-1

Garelick Designer Series Padded Deck Chair

Very comfortable, high quality deck chair features beautifully sewn Olefin fabric, tastefully appointed with embroidered code flag design and contrasting accent trim. Lightweight and sturdy, with 1" aluminum corrosive resistant double leg frame. Varnished hardwood arms.



GAR 35029-62

Garelick Mariner Folding Chair

Beautiful weatherproof sewn white cushions and arm rests provide extra comfort. Solid strength and stability provided by eight legged frame. Dual locks prevent folding during use.

- Seat size: 19" W x 15-1/2" D x 3-1/2" thick
- Overall width: 26"



GAR 48106-61 Anodized frame

Garelick Chair & Table Tips

For 1" chair legs and tubing ends.

- GAR 76010** 4/pkg, poly
- GAR 76011** 4/pkg, rubber

Double leg chair tips.

- GAR 76012** 2/pkg, poly

