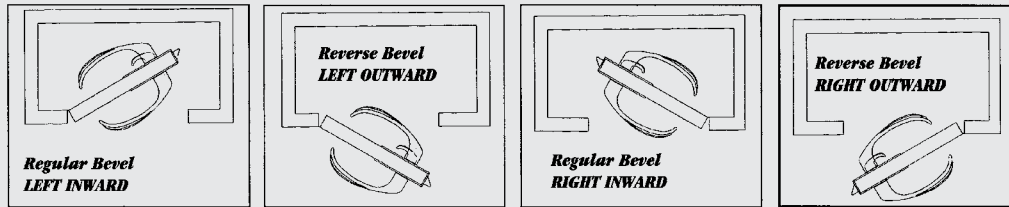

<b>Cabinet Hardware</b>	Perko Door Latch Sets	292 - 294
	Catches / Pulls / Latches	294 - 302
	Barrel Bolts / Hasps / Door Hooks	302 - 306
	Handles	306 - 307
	Hinges	307 - 313
	Coat & Utility Hooks	313 - 315
<b>Angle Brackets</b>		315
<b>Storage Clips</b>		315 - 316
<b>Fans</b>		317 - 319
<b>Glove Boxes</b>		319
<b>Mats</b>		319
<b>Velcro &amp; Rubber Clamps</b>		319

**Determining the bevel required on a LOCK or LATCH**

When standing outside, if the door opens away from you, then you need a lock or latch with a regular bevel. But if the door opens toward you then you need a lock or latch with a reverse bevel.

**Perko Mortise Lock Set**

Chrome plated zinc. Locked by dead bolt from inside, or key from outside.

- For doors: 1" to 1-3/8"
- Case size: 2-3/4" x 2"
- Escutcheon plate: 4-3/8" x 1-1/4"

**PER 927-DP-CHR**

Replacement Parts:

- PER 962-000-CHR** Knob and handle assembly  
**PER 920-DP-CHR** Reverse bevel and cam  
**PER 927-000-99B** Escutcheon plate with keys  
**PER 913-DP-CHR** Flush strike plate

**Perko Mortise Latch Set**

Chrome plated zinc. Locked by dead bolt from inside, no keys.

- For doors 1" to 1-3/8"
- Case size: 2-1/4" x 1-13/16"

**PER 960-DP-CHR**

Replacement Parts:

- PER 962-000-CHR** Knob and handle assembly  
**PER 960-000-99A** Bevel and cam

**Perko Mortise Latch Sets**

Chrome plated zinc construction with sliding lock knob.

- For doors: 1/2" - 3/4"
- Case dimensions: 1-5/8" x 1-5/8"
- Escutcheon plate: 2" x 2-1/4"



- PER 991-DP0-CHR** Regular bevel inward opening door  
with flush strike,  
**PER 992-DP0-CHR** Reverse bevel with flush strike, outward opening door

Replacement Parts:

- PER 912-DP-CHR** Flush strike plate  
**PER 920-DP-CHR** Reverse bevel and cam  
**PER 984-000-CHR** Regular bevel and cam

**Perko Mortise Latch Sets**

Mortise type door locks are designed for interior applications such as head enclosures and areas of the ship where security is needed.

- Chrome plated zinc, brass and plastic
- New contemporary styling
- Overall height 5-1/4"
- Safety unlock from outside
- Interior lock mechanism
- Chromed escutcheon plates



- PER 710-001-LIC** Left in or right out 3/4"-1"  
**PER 710-001-RIC** Right in or left out 3/4"-1"  
**PER 710-002-LIC** Left in or right out 1" - 1-1/4"  
**PER 710-002-RIC** Right in or left out 1" - 1-1/4"  
**PER 710-003-LIC** Left in or right out 1-1/4" - 1-1/2"  
**PER 710-003-RIC** Right in or left out 1-1/4" - 1-1/2"

**Perko Rim Latch Sets**

Chrome plated zinc. Locked by slide button from inside, no keys.

- For doors: 5/8" to 1-3/8"
- Case size: 2-1/8" x 1-3/4"

- PER 928DP-CHR** Regular bevel with box strike, inward opening door  
**PER 930DP-CHR** Reverse bevel with flush strike, outward opening door

Replacement Parts:

- PER 962-000-CHR** Knob and handle assembly  
**PER 920-DP-CHR** Reverse bevel and cam  
**PER 984-000-CHR** Regular bevel and cam  
**PER 976-CHR** Box strike

**Perko Rim Latch Sets**



New style rim latch sets from Perko. Chrome plated zinc construction with sliding lock button.

- For doors: 1/2" - 1"
- Case dimensions: 2" x 2-1/4"
- Escutcheon plate: 2" x 2-1/4"

- PER 929-DP-CHR** Regular bevel with box strike, inward opening door
- PER 968-DP-CHR** Regular bevel with flush strike, inward opening door
- Replacement Parts:
- PER 912-DP-CHR** Flush strike plate
- PER 920-DP-CHR** Reverse bevel and cam
- PER 984-000-CHR** Regular bevel and cam
- PER 977-CHR** Box strike plate

**Perko Rim Lock Sets**



Chrome plated zinc. Locked by dead bolt from inside, or key from outside.

- For doors: 5/8" to 1-3/8"
- Case size: 3-7/8" x 2"
- Escutcheon plate size: 4-3/8" x 1-1/4"

- PER 918-DP-CHR** Regular bevel with box strike, inward opening door.
- PER 919-DP-CHR** Reverse bevel with flush strike, outward opening door

- Replacement Parts:
- PER 962-000-CHR** Knob and handle assembly
- PER 920-DP-CHR** Reverse bevel with cam
- PER 913-DP-CHR** Flush strike plate
- PER 918-000-99A** Box strike plate for 918

**Perko Tubular Latch Set**

Chrome plated zinc. Locked by dead bolt from inside, no keys. Quick and easy to install.

- For doors: 1" to 1-3/8"
- Tube diameter: 3/4"
- Escutcheon size: 4-3/8" x 1-1/4"



- PER 567-DP-CHR**
- Replacement Parts:
- PER 962-000-CHR** Knob and handle assembly

**Perko Flush Cup Rim Latch Set**



Made from chrome plated zinc. For door thickness 5/8" to 1". Comes with black plastic spacer for surface mounting.

- Case 2" x 2-1/4", Cup OD: 2-1/4"

- PER 1239-DP-CHR** Regular bevel with strike box

**Perko Flush Lock & Latches**

Made of chrome plated zinc and black impact resistant plastic. S/S stem and lock nut. Comes with offset cam bar and flexible plastic strike plate. Easily installs in a 2" diameter hole. Detents indicate open or closed position.

- For doors: 1/4" to 1-1/8" thick
- Adjustment latch bar: 3/8" - 3"
- Face plate dimensions: 2-1/2" x 2-1/2"

Locking latch with two keys. Offset cam bar with flexible plastic strike. (As shown in picture)

**PER 931-DP1-BLK**



Locking latch with two keys. Offset adjustable cam bar.

**PER 931-DP2-BLK**

Non-locking latch. Offset cam bar with flexible plastic strike

**PER 932-DP1-BLK**

**PER 932-DP1-WHT**



Non-locking latch. Offset adjustable cam bar.

**PER 932-DP2-BLK**

Hinged water resistant cover fits 931 and 932 lock and latch assemblies. Black, fibre reinforced plastic.

**PER 1089-DP1-BLK**

- Parts:
- PER 931-002-99A** Offset adjustable cam bar



**Perko Flush Lock and Latches**



Large handle allows two finger grip. Made of chrome plated zinc and black impact resistant plastic. S/S stem and lock nut. Flush mounts in a 2-3/8" x 2-3/8" hole. Surface mounts in a 1-5/8" diameter hole.

- For doors: 1/8" - 3/4" thick
- Adjustment latch bar: 1/2" - 3"
- Face plate dimensions: 3-1/8" x 3-1/8"

**PER 1031-DP1-BLK** Locking latch with 2 keys

**PER 1032-DP1-BLK** Non-locking latch

Hinged water resistant cover fits 1031 and 1032 lock and latch assemblies. Black, fibre reinforced plastic.

**PER 1089-DP3-BLK**



### Perko Flush Hatch Dog

For securely fastening deck hatches. Chrome plated brass. S/S lock nuts. Comes with flush strike. For hatches up to 2" thick. Use #8 fasteners.



Part #	Face Plate L x W	Max. Adjustment Latch Bar
PER 777-000-CHR	3-13/16" x 3"	1-1/4" - 2"

### Perko Flush Lock and Latches

Chrome plated zinc. Locking type with S/S tumbler assembly. Supplied with 2 keys.

- For doors: 1/2" to 3/4"
- Size: 2-1/4" x 2"

PER 921-DP-CHR

PER 922-DP-CHR As above except without lock

Parts:

PER 980A Spare cam bar (chrome) for 921 & 922



### Perko "T" Handle Flush Lock and Latches

Popular "T" handle lock. Black plastic body, handle is zinc and stem is S/S. Rubber seals the lock cylinder preventing water intrusion. Fits into a 2-1/2" diameter hole.

- Mounting surfaces: 1/8" to 3/4"
- Adjustable cam bar: 3/4" to 2-3/8"
- Face plate dimensions: 3"

PER 1091-DP1-BLK Locking style comes with 2 keys

PER 1092-DP1-BLK Latch (Non locking)



### Sea-Dog Surface Mount Locking Lifting Ring

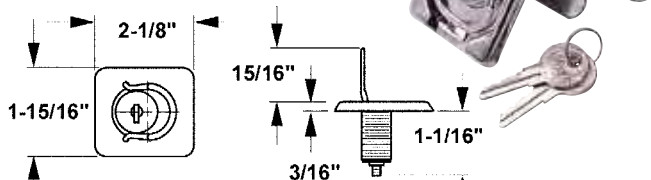

Stamped 304 S/S construction with die cast lock. Comes with two types of locking arms for either flush or offset installations.

SED 221831-1

### Sea-Dog Round T-Handle Latch

Investment cast 316 S/S.

- Dia: 2-7/16" x Depth: 1-3/8"
- Cutout: 2"

SED 221910



### Whitecap Slam Latches

316 S/S construction, locking or non-locking styles.

- Flange: 2-3/18"
- Depth: 15/16"

WHI S-0227C Standard

WHI S-0228C Locking



### Whitecap Locking 'T' Handles

White or black nylon and coated zinc construction.

- Diameter: 3"
- Cutout: 2-1/2"
- Depth: 2-3/4"
- Minimum mount thickness: 1/8"

WHI S-0226BC Black

WHI S-0226WC White



### Wren Clamping Hatch Handle

Unique action handle by way of rotating, clamping which is adjustable and with the added advantage of a secure reliable key lock. Incorporates the unique flat polishing to retain perfect visible appearance. All hatch handles are supplied with the installation fixing ring and striker block. 316 S/S.

- Cutout: 71 mm (2-5/8")
- Overall diameter: 80 mm (3-1/8")
- Depth: 47 mm (1-7/8")

WRE 15022



### Wren Finger Pull

This product compliments the Wren range of deck hardware, being simple to operate and install and comes complete with backing plate. Features unique flat polishing to retain perfect visible appearance. Stainless steel.

- Cutout: 2-3/8"
- Overall diameter: 2-3/4"
- Depth: 3/4"

WRE 8385



### Wren Snap Shut

This product gives a totally positive "shut" feel. Ideal for use in wet lockers (horizontal and vertical installation) interior joinery, overhead lockers and interior furniture. Incorporates a unique flat polishing to retain perfect visible appearance. The snap shut comes complete with backing plate. Designed to match hatch handle and finger pull. Secure non-locking spring loaded catch.

Suitable for, 'wet lockers', vertical hatches & small doors

- Cutout: 2-3/8"
- Overall diameter: 2-3/4"
- Depth: 3/4"

WRE 8925



**Gemlux S/S Lift Pulls**

Cast S/S, 2 finger pull. This product gives a totally positive "shut" feel with a 180° turn. Includes a backing plate, straight and offset cams.



- GEM 3302260-1 3-1/2"
- GEM 3302264-1 2-1/2"

**Gemlux S/S Slam Latches**



Cast S/S, spring loaded, 2 finger pull. 2" hole installation. This product gives a totally positive "shut" feel. Ideal for use in wet lockers (horizontal and vertical installation) interior joinery, overhead lockers and interior furniture.

- Comes with mounting brackets for panels over or under 1/2" thick
- Locking or non-locking styles
- Long & short screw sets

- GEM 3304150 Locking
- GEM 3304151 Non-locking

**TH Marine Slam Latches**

- New oval-top, nautical design
- Low profile
- Totally corrosion resistant
- UV stable, resistant to chemicals, acetone, gasoline.
- Simple installation in 2" round hole
- S/S pawl catch & mounting hardware



- THM NFSL-5-1-DP Black
- THM NFSL-5-2-DP White

**Sea-Dog Flush Mount Slam Latches**

- Injection molded nylon
- Use #12 RH fasteners
- Dia: 2-7/16" x Depth: 1-1/2"

- SED 228120-1 White
- SED 228125-1 Black



**Sea-Dog Hatch Cover Pull**

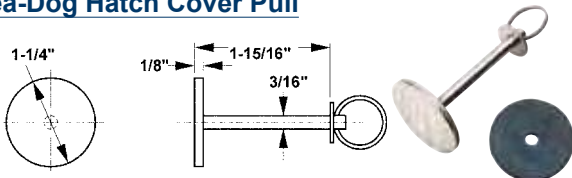

- 304 stamped S/S.
- SED 221840-1

**ITC Hatch Lift Pins**

S/S lift pin, washer and retaining ring with rubber "grommet" to protect gel coat and reduce rattle. Head is 1-1/4" diameter, pin is 1/4" x 2" length.



- ITC 84250 3"
- ITC 84251 2"

**Orcas "T" Handle Latches**

**Boss Type**



- Spring loaded anti-rattle system with or without locking pawl
- 316 S/S construction with no exposed fasteners in a 4-point bossed design
- 2-3/4" installation hole required
- Comes with pawl (stamped S/S # 8821207-L)

- ORC 9021243-2 Latch
- ORC 9121423-4 Locking latch

**"T" Handle Latch**

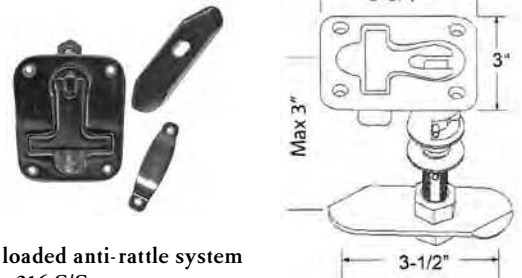

- Spring loaded anti-rattle system
- Durable 316 S/S
- 2-3/4" installation hole required
- Comes with pawl (stamped S/S # 8821207-L)

- ORC 9021234-4

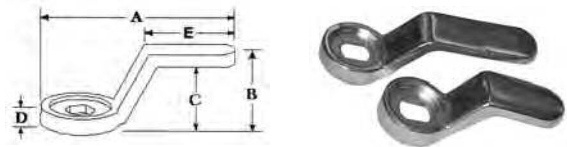

Optional cast stainless steel offset pawls for "T" handle latches

Optional Pawls	A	B	C	D	E
ORC 8821207-D	2-5/8"	1"	7/8"	3/8"	1-3/8"
ORC 9021216.8	3-3/8"	1"	7/8"	3/8"	1-7/8"

**Sea-Dog Hatch Handle**

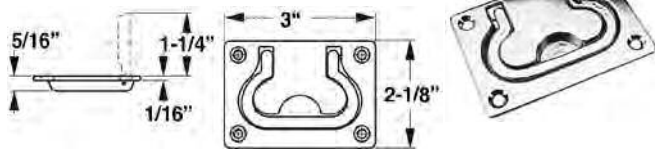

Chrome plated brass.

- Use #8 FH screws

SED 222420-1

**Sea-Dog Flush Hatch Handle**

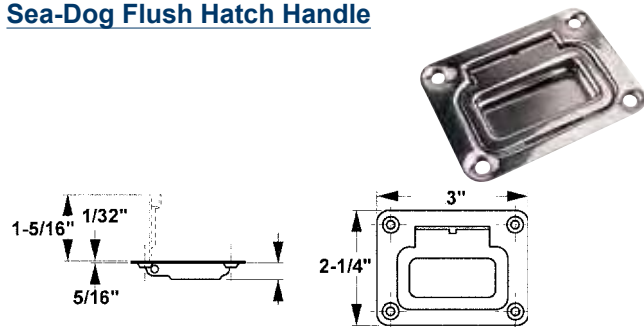

Stamped S/S, with a spring return.

- Use #8 fasteners

SED 221820-1

**Sea-Dog Flush Hatch Handle**

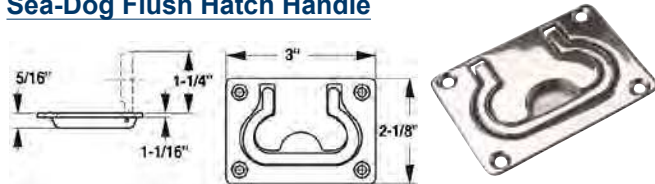

Investment cast 316 S/S.

- Use #8 fasteners

SED 221860

**Sea-Dog Hatch Handles**

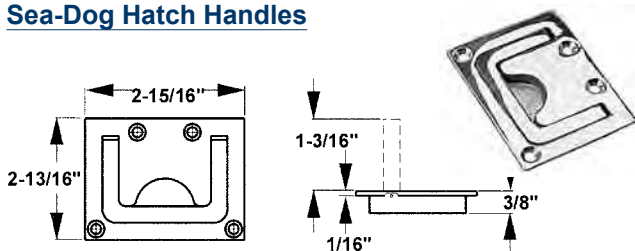

- Cast brass
- Use #8 FH screws

SED 222425-1

Chromed brass

SED 222426-1

Brass

**Perko Flush Lifting Handle**

- Chrome plated zinc
- Use: #8 fasteners
- Size: 3" x 2-1/4"
- Inside handle: 1-7/8" x 1"

PER 1220-DP-CHR



**Perko Flush Lifting Handles**

Cast bronze. Chrome plated finish.

DP2 has all mounting holes at corners.

- Uses #8 fastener



Part #	Size	Inside Handle
PER 776-DP1-CHR	3" x 2-1/4"	1-7/8" x 1"
PER 776-DP2-CHR	3-3/4" x 2-3/4"	2-3/16" x 1-3/16"

**Sea-Dog Ring Pull**

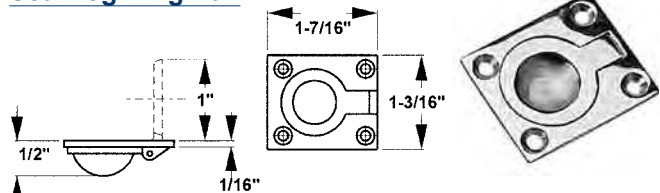

- Cast brass
- Uses #4 fasteners

SED 222395-1

**Sea-Dog Ring Pulls**

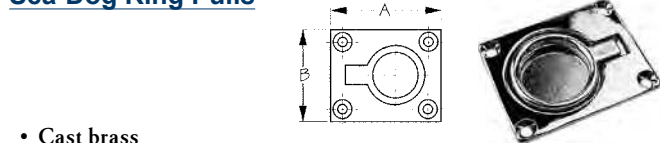

- Cast brass

Part #	A	B	Finish	Fastener
SED 222400-1	1-3/4"	1-1/2"	Chrome	#6 FH
SED 222405-1	1-3/4"	1-1/2"	Brass	#6 FH
SED 222410-1	2-1/2"	2"	Chrome	#8 FH
SED 222415-1	2-1/2"	2"	Brass	#8 FH

**Sea-Dog Flush Lift Handles**

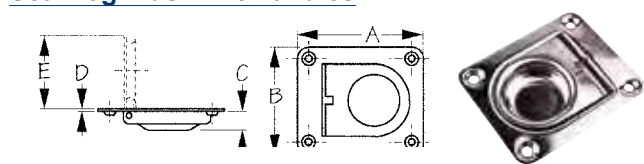

- Stamped 304 S/S
- Pull handle is spring loaded to stay closed

Part #	A	B	C	D	E	Fast
SED 221810-1	2-9/16"	2-3/16"	7/16"	1/32"	1-1/2"	#8 FH
SED 221815-1	1-3/4"	1-1/2"	7/16"	1/32"	1"	#6 FH

**Sea-Dog Ring Pull**

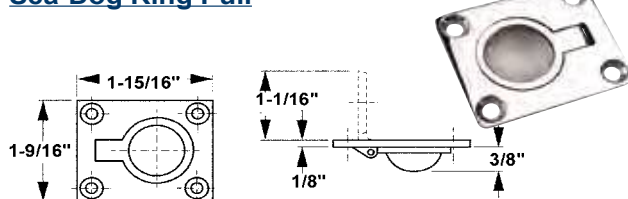

- Investment cast 316 S/S
- Use #8 fasteners

SED 221850-1

**Perko Flush Ring Pull**

- Chrome plated bronze
- Use #8 fasteners
- 2-5/8" x 2"

PER 575-DP-CHR



**Perko Flush Ring Pull**

- Chrome plated zinc
- Use #6 fasteners
- 1-3/4" x 1-3/8"

PER 841-DP-CHR



**Perko Flush Ring Catch**

- Chrome plated zinc
- Bronze spring
- Use #6 fasteners
- 2-1/4" x 1-3/8"

PER 1051-DP-CHR



**Perko Flush Ring Pull**

- Chrome plated zinc
- Use #6 fasteners

PER 1232-DP1-CHR  
PER 1232-DP2-CHR

1-5/8"  
2"



**Perko Flush Ring Pull**

- Chrome plated bronze
- Use #8 fasteners
- 2-9/16" x 2"

PER 1103-DP-CHR



**Perko Flush Pull**

- Chrome plated zinc with black plastic finishing flange
- Spring loaded
- Can be mounted horizontally or vertically
- Use #8 fasteners
- 3-1/4" L x 3/4" W

PER 1221-DP-CHR



**Perko Door Button**

- Chrome plated zinc
- Black plastic knob
- Uses #6 F.H. fasteners
- Diameter: 1-3/4"

PER 1216-DP-CHR



**Sea-Dog Door Buttons**

- Brass
- Uses #6 FH fasteners
- Dia: 1-3/4"

SED 222360-1  
SED 222365-1

Chromed  
Brass



**Sea-Dog Cupboard Bolt**

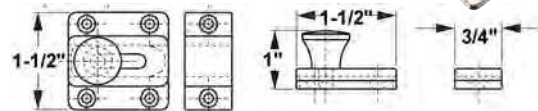

- Chrome plated extruded brass
- Uses #5 F.H. fasteners

SED 222380-1



**Perko Cupboard Bolt**

- Chrome plated zinc with black plastic slide and knob
- Uses #6 F.H. fasteners
- 2-1/8" x 1-1/2"

PER 1101-DP-CHR



**Perko Latch**

- Chrome plated zinc with sliding lock button
- Uses #6 F.H. fasteners
- Overall size: 2-1/8" x 2-1/4"

PER 948-DP-CHR

Parts:

PER 984-000-CHR  
PER 976-CHR

Spare bevel with cam  
Spare strike plate



**Perko Cupboard Catches**

- Chrome plated zinc
- Uses #6 F.H. fasteners
- Overall size: 1-1/2" x 1-7/8"

PER 1102-DP1-CHR  
PER 1102-DP2-CHR

Flush  
Offset



**Lamp Push Button Maxi Latches**

Unit opens and closes with pressure. Body is made of plastic and complementary knobs and dress rings are made of S/S. Strike plate is made of nickel.



\*Order 4 parts each for a complete package.

- LMP 374966** Large body, 5.5 cm x 4.5 cm
- LMP 374990** Large strike plate
- LMP KNOB/SS/LG** Large S/S knob
- LMP RING/SS/LG** Large S/S ring
- LMP RING/BR/LG** Large brass ring
- LMP 374971** Small body, 3 cm x 3.5 cm
- LMP 374991** Small strike plate
- LMP KNOB/SS/SM** Small S/S knob
- LMP RING/SS/SM** Small S/S ring

**Lamp Push Knob With Latches**

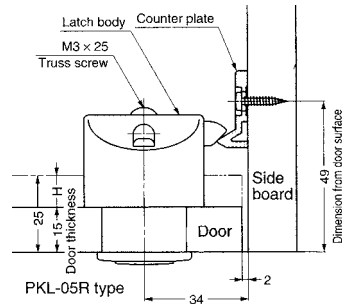

Pushing in the knob activates and secures the latch so the door will not open until the knob is pushed again. Zinc die cast with chrome or gold finish. Fits 19/32" to 63/64" thick doors. Left side latching, comes with screws.

- LMP PKL-08/CR** Chrome push knob
- LMP PKL-08/GA** Gold push knob
- LMP PKLS-WHT** White plastic latch body

\* Note - Order a push knob and body for a complete set.

**Lamp Push Button Catches**

- Manufactured in plastic with a choice of knob finish.
- Material: Latch Body - Polyamide
- Supplied with S/S screws



**Knobs**

- LMP TLP-BB-CR** Chrome
- LMP TLP-BB-PB** Polished brass
- LMP TLP-BB-SN** Satin nickel

**Bodies**

- LMP TLP-LB-WHT** Bar latch body white
- LMP TLP-LBM-WHT** Latch body white

**Lamp Magnetic Touch Latches**

Push to open, push to close. May require a handle or knob. Supplied with screws.

- LMP ML-80BLK** Black
- LMP ML-80WHT** White

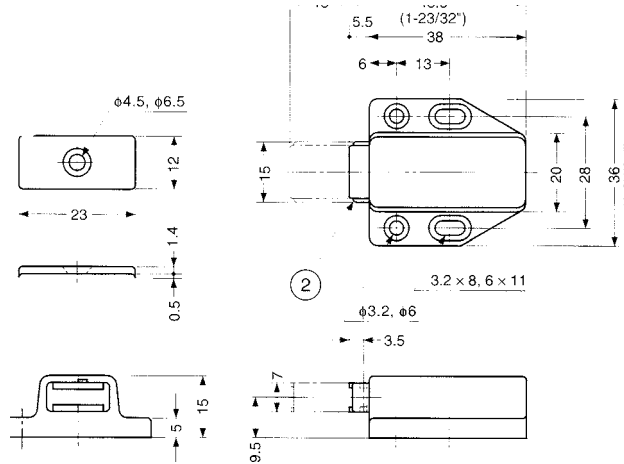

**Lamp Safe Push Latches**

Push to open, push to close. No need for door handles or pulls. Supplied with screws. Can not be pulled open.

- LMP MC-37BLK** Black
- LMP MC-37WHT** White

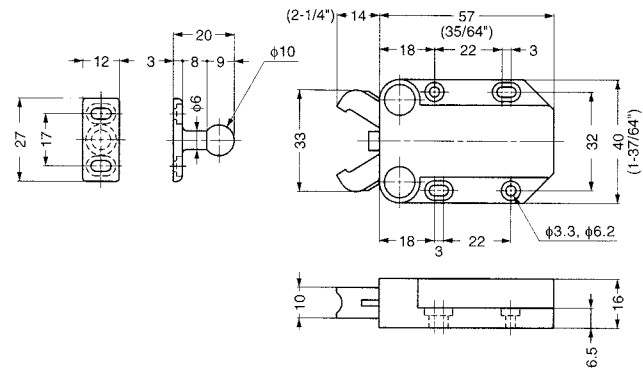

**Orcas Transom Door Latch**

- Spring bolt
- 316 stainless steel
- Features an adjustable slide bolt
- Comes with a striker plate
- Can be adjusted to fit the swing by removing the handle and turning the pawl
- L: 4-3/16" (5-1/4" with catch) x H: 2" x D: 3/4"



ORC 9121322

**Sea-Dog Push Button Cabinet Latch**

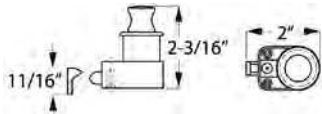

- Chrome plated brass button
- Plastic body



SED 226312-1 Packaged

**Sea-Dog Push Button Rim Latches**

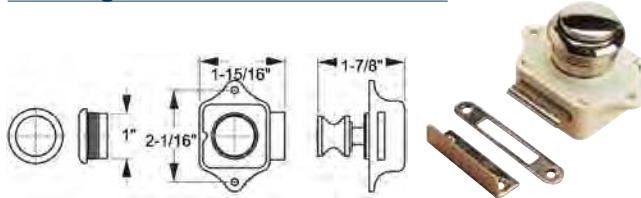

Brass or stainless and plastic construction, comes complete with two strike plates. Hole spacing on flat strike plate is 1-7/8"; hole spacing on 90 degree strike plate is 1-3/16".

#4 FH fasteners

- Recommended door thickness 7/8"
- Latch fastener: #6

SED 224300-1 Polished chrome  
 SED 224301-1 Polished brass  
 SED 225300-1 S/S

**Lamp Bar Catches**

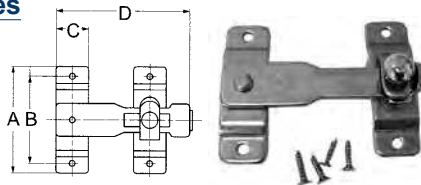

- 18-8 polished S/S
- Supplied with S/S fasteners

Part #	A	B	C	D
LMP BL-80	65mm	53mm	20mm	84mm
LMP BL-100	80mm	66mm	25mm	105mm

**TH Marine Pontoon Gate Latch**

All parts install on gate only.

- Operates on right or left hinged gates
- Fits 1", 1 1/8" or 1 1/4" square tube
- Prevents gate from swinging inward
- Nylon molded parts, prevent rattling
- Easy installation



Note\* Not designed as a safety or load bearing device.

THM GL-2-DP Grey

**Buck Algonquin Transom Door Latch**

- S/S - 316
- Bracket size: 3" x 1-1/2"
- Bolt size: 1/4"
- Length of handle: 6-1/4"



BUC 70TDLS-625SM  
 BUC TDLS-625L Latch only

**Marine Works Cam Locks**

Turns any drawer or cabinet into a personal safe. Complete with mounting hardware.

- MWK 49310 For panels up to 5/8"
- MWK 49320 For panels up to 3/4"
- MWK 49330 For panels up to 1"



**Lamp Rotary Catches**

Plastic, white in colour. Good for at least 300,000 operations.

- LMP 6900/WHT 1-1/8" wide
- LMP 6901/WHT 1-7/32" wide



**Lamp K-Catch**

Plastic catch, natural white, 1-13/32"

- LMP K-CATCH/WHT Bulk



**Sea-Dog Roller Catch**

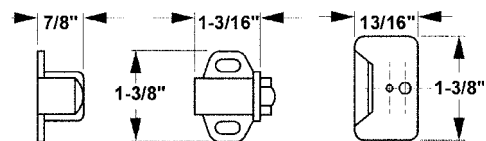

- Injection molded nylon
- Surface mount
- Display package
- Use #8 fastener



SED 227108-1

**Sea-Dog Double Ball Catches**

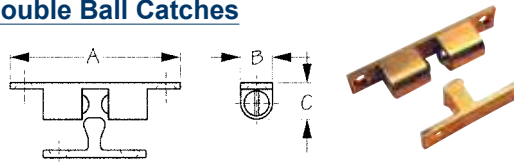

Adjustable spring loaded ball catch that allows for easy adjustment of the holding strength of each catch depending on the door size.  
*Solid brass*

Part #	A	B	C	Fast	Qty
SED 222841	1-11/16"	5/16"	3/8"	#4 FH	
SED 222841-1	"	"	"	"	2/pkg
SED 222842	1-15/16"	3/8"	7/16"	#4 FH	
SED 222842-1	"	"	"	"	2/pkg
SED 222843-1	2-5/16"	7/16"	1/2"	#6 FH	
<i>Chromed solid brass</i>					
SED 222822-1	1-15/16"	3/8"	7/16"	#4 FH	2/pkg
SED 222823-1	2-5/16"	7/16"	1/2"	#6 FH	2/pkg

-1 suffix denotes retail packaging

**Cruiser Hardware Double Ball Catches**

Adjustable spring loaded ball catch that allows for easy adjustment of the holding strength of each catch depending on the door size.

- Solid extruded brass
- Width 5/16"
- Each



Part #	Length	Fast	Finish
CRU P6281/A-SD	1-11/16"	#4 FH	Brass
CRU P6281/B-SD	1-15/16"	#4 FH	Brass

**Perko Door Catch**

White plastic. Comes with screws.

- Length: 1-1/4"

PER 554-DP 2/pkg



**Orcas Grabber Catch Latch**

- Pull to open
- Catch snaps into frame
- Fits into frames from 1.1 (.043) to 7 (.276) thick
- Corrosion-resistant materials
- Spring-loaded over-centre latching

ORC C3-810



**Perko Elbow Catch**

Chrome plated zinc.

- Size: 1-1/8" x 9/16"

PER 1056-DP-CHR



**Perko Door Catch**

- Black plastic
- Stud size: 1-1/8" x 3/8"
- Catch size: 1-3/8" x 7/8"

PER 559-DP 2/pkg



**Perko Plastic Elbow Catch**

Black plastic with integral spring.

- Use #6 fasteners
- Size: 1-3/16" x 5/8"

PER 1021-DP-BLK 2/pkg



**Perko Door Holder**

- S/S clip
- Chrome plated zinc arrow
- Base size: 1-5/8" x 3/4"
- Clip size: 1-3/8" x 7/16"

PER 1065-DP-CHR



**Sea-Dog Elbow Catches**

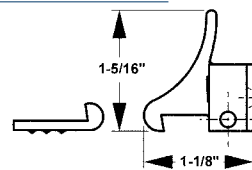

SED 222330-1 Chromed brass  
SED 222335-1 Brass

**Cruiser Wall Type Door Catch**

- Hot pressed brass
- Chrome plated finish
- Spring clip adjustable by turning fastening screws
- Length: 3-1/2"

CRU P4010-CP



**Sea-Dog Door Stop & Catch**

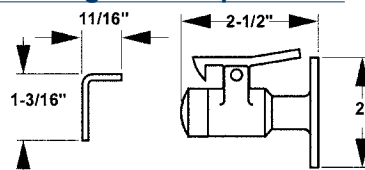

- Investment cast 316 S/S
  - Comes complete with white rubber bumper
  - S/S spring
- SED 221710-1

**Sea-Dog Door Stop & Catches**

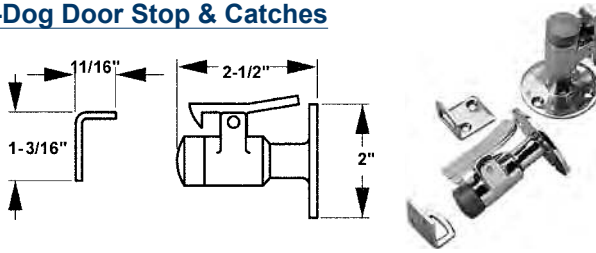

- Comes complete with white rubber bumper
- S/S spring
- Use #6 fasteners

**SED 222710-1** Chrome  
**SED 222712-1** Brass

**Sea-Dog Door Bumper**

- Cast brass
- Uses #6 fasteners
- Diameter: 1-7/8"

**SED 222720-1** Brass chrome plated  
**SED 222722-1** Brass



**Sea-Dog Sliding Door Stop**

- Stainless steel
- L: 2-7/8" x W: 1-1/4"
- Use #8 fasteners

**SED 221700-1** Each



**Perko Door Stop & Holders**

- Chrome plated bronze with rubber bumper
- Diameter: 1-3/4"

**PER 574-DP1-CHR** 2-3/8" Long  
**PER 574-DP2-CHR** 3-1/4" Long



**Whitecap Door Holder w/Cushion**

- 316 Stainless steel construction
- Base Diameter: 7/8" x Standoff Length: 2-7/16"
- Uses #10 fasteners x (5)

**WHI S-040**



**Perko Sliding Window Locks and Anti-Rattlers**



- Chrome plated zinc with black plastic knob and tip
- Uses #6 fasteners

Part #	Height	Mounting Plate	Adjustment
<b>PER 937-DP-CHR</b>	1-5/8"	1" x 5/8"	1-1/8"
<b>PER 934-DP-CHR</b>	1"	2" x 5/8"	1-1/8"

**PER 944** Spare plastic tip for 934 & 937

**Lamp Magnetic Door Holders**

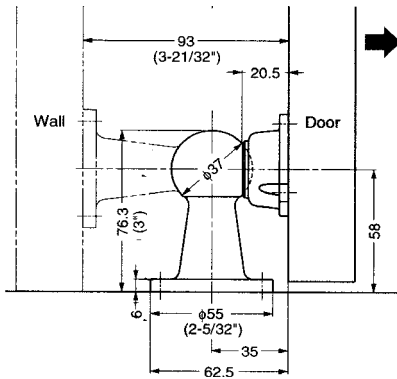
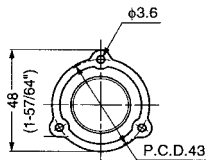

- Made of plastic
- Supplied with screws

**LMP SMDH-BRN** Brown  
**LMP SMDH-IVY** Ivory

**Sea-Dog Anti-Rattle Window Fastener**

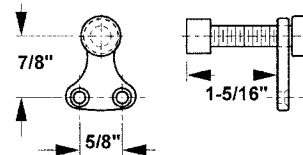

- Chrome plated sand cast brass
- Use #6 fasteners

**SED 322210-1**

**Perko Sliding Window Stop**

- Chrome plated zinc
- Mounting plate size: 1-7/8" x 3/4"
- Stopping plate length: 1-1/2"
- Uses #8 fasteners

**PER 935-DP-CHR**



**Perko Door Stop**

- Chrome plated zinc with rubber bumper
- Diameter: 1-1/4"
- Projection: 1"

**PER 1177-DP-CHR**



**Sea-Dog Male Windshield Retainer**

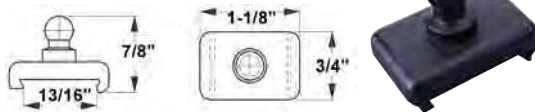

- Black injection molded nylon

SED 324330-1

**Sea-Dog Windshield Brace Foot**



- Black injection molded nylon

SED 324300-1

**Sea-Dog Male Windshield Retainer Spacer**

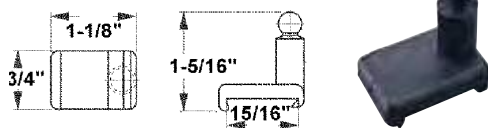

- Injection molded nylon

SED 324360-1

**Sea-Dog Nylon Windshield Double Latch**

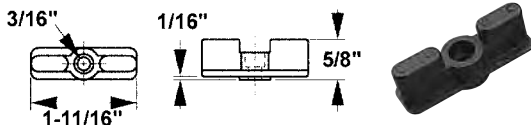

- Black injection molded nylon

SED 324210-1

**Perko Sliding Window Handle**

- Polished S/S
- For 1/4" thick glass
- Length: 3"

PER 954-DP-STS



**Gemlux Barrel Bolts**

316 cast S/S in a slim line design with built-in anti-rattle friction plate for a snug fit.

- Use #6 fastener

GEM 3301485 3-1/2" x 1"

GEM 3301486 4-3/4" x 1"



**Sea-Dog Barrel Bolt**

- Length: 2-7/8", striker: 3/4", H: 1/2"
- Chrome plated sand cast brass
- Use #6 fastener

SED 222522-1



**Perko Barrel Bolts**

Chrome plated bronze. Supplied with black friction pad to eliminate rattle and provide smooth operation.

- Use #6 fasteners
- Width: 1-7/16"

PER 947-DP1-CHR 3-7/16" long

PER 947-DP2-CHR 4-5/16" long

PER 947-DP3-CHR 5-1/4" long



**Lamp Spring Loaded Barrel Bolt**

18-8 S/S. Supplied with S/S screws.

- Width: 33 mm

LMP BLS-60 85.4 mm long

LMP BLS-90 115.4 mm long



**Sea-Dog Barrel Bolt**

- Chrome plated extruded brass
- Use #6 fasteners
- 1/2" striker
- Height: 3/8"

SED 222500-1 1-1/2"

SED 222501-1 2"

SED 222502-1 2-1/2"

SED 222503-1 3"



**Cruiser Barrel Bolts**

- Solid drawn brass
- Use #4 fasteners
- Width: 1"
- Pin diameter: 5/16"

Chrome/Brass	Polished/Brass
CRU PC2002 2"	CRU PB2002 2"
CRU PC2002 2-1/2"	CRU PB2002 2-1/2"
-	CRU PB2002 3"
CRU PC2002 4"	CRU PB2002 4"



**Perko Barrel Bolt**

Chrome plated zinc. Integral friction pad eliminates rattles and provides smooth operation.

- Uses #8 fasteners
- Overall: 3-3/8" x 1-1/4"

PER 1244-DP-CHR



**Lamp Slide Bar Catch**

- Satin finish 18-8 S/S
- Supplied with S/S screws

**LMP KR-50**

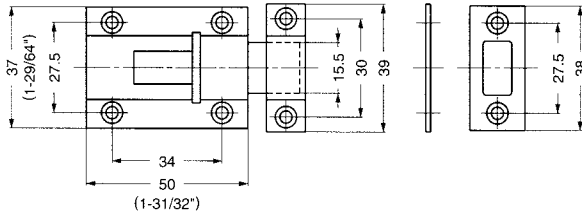

**Perko Ship Bolt**

- Chrome plated bronze
- Use #6 fasteners
- Size: 2-5/8" x 1-1/4"

**PER 1053-DP-CHR**



**Lamp Gate Latches**

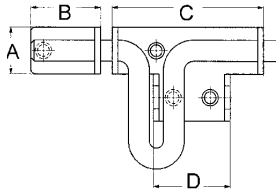

- 18-8 S/S
- Supplied with S/S screws
- Packaged

Part #	A	B	C	D
<b>LMP SSG-45</b>	14mm	21mm	45mm	25mm
<b>LMP SSG-65</b>	20mm	30mm	65mm	33mm

**Marine East Barrel Bolt Slots**

Molded in high-impact nylon. 3/8" diameter opening accepts a range of standard barrel bolts.

- Installation: 5/8" hole

**MEP 4400** Black  
**MEP 4400W** White



Nylon Slot Only

**Perko Swivel Eye Hasp**

Chrome plated zinc. Padlock eye swivels to act as a latch.

- Use #6 fasteners
- Length: 3" x Width: 1"
- Padlock clearance: 11/32"

**PER 1194-DP-CHR**  
**PER 1194-DP-99A** Spare keeper



**Perko Chrome Plated Zinc Hasps**

- Chrome plated zinc hasp
- Use #6 fasteners
- Width: 1" x Length: 3"
- Padlock clearance: 9/32"

**PER 1198-DP1-CHR** 2"  
**PER 1198-DP2-CHR** 3"  
**PER 1198-DP3-CHR** 3-3/4"



**Perko Bronze Hasps**

- Chrome plated bronze
- Use #6 fasteners
- Width: 1". Length: 3"
- Padlock clearance: 9/32"

**PER 998-DP1-CHR** 2"  
**PER 998-DP2-CHR** 3"



**Spare Chrome Keeper**

**PER 959-DP-CHR** 2/pkg

**Sea-Dog Safety Hasps**

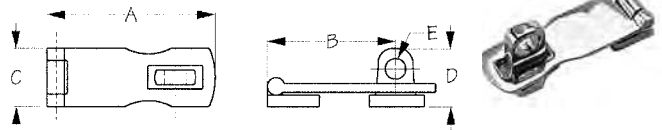

- Cast brass
- Uses #6 fasteners

Part #	A	B	C	D	E	Finish
<b>SED 222125-1</b>	3"	2-1/4"	1"	1"	3/8"	Chrome
<b>SED 222126-1</b>	3"	2-1/4"	1"	1"	3/8"	Brass
<b>SED 222140-1</b>	3-1/2"	2-3/8"	1"	1"	3/8"	Chrome

**Sea-Dog S/S Safety Hasps**

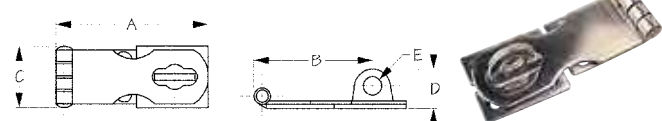

- Stamped 304 S/S
- Use #6 fasteners

Part #	A	B	C	D	E
<b>SED 221120-1</b>	2-11/16"	2-1/16"	1-1/16"	11/16"	5/16"
<b>SED 221124-1</b>	3-13/16"	3-1/16"	1-1/16"	11/16"	5/16"

**Sea-Dog S/S Swivel Hasp**

- Stamped 304 S/S
- Staple swivels to act as a latch
- Use #6 fasteners

**SED 221130-1**

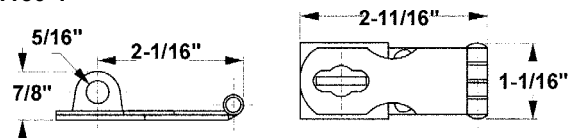

**Sea-Dog Swivel Hasps**

- Cast brass construction
- Use #6 fasteners

SED 222130-1 Chromed brass  
 SED 222135-1 Brass

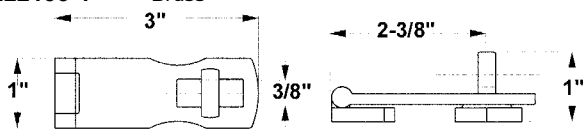

**Sea-Dog Heavy Duty Hasps**

- Cast brass construction
- Use #8 fasteners

SED 222150-1 Chromed brass  
 SED 222155-1 Brass

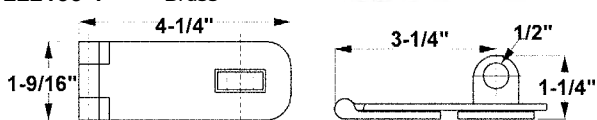

**Sea-Dog Heavy Duty Swivel Hasps**

- Stamped 304 S/S
- Use #8 fasteners

SED 221135-1 Flush  
 SED 221136-1 Angle

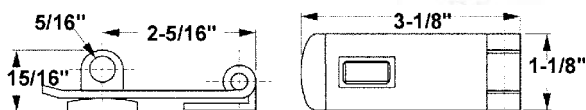

**Sea-Dog Swivel Hasps**

- Chrome plated zinc
- Swivel bale
- Use #8 fasteners

SED 224130-1 Flush  
 SED 224131-1 Angle

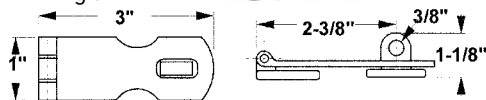

**Cruiser Hasp and Swivels**

- Electro-polished S/S
- Use #8 fasteners
- Hasp and staple sold individually
- Closed length 3" x Width: 1-1/8"

CRU M0827-S/S Hasp  
 CRU M0627-S/S Swivel staple



**Sea-Dog Locking Hasp**

- Stamped 304 S/S
- Use #8 fasteners
- L: 3-1/8" x W:1-1/4"

SED 221150-1



**Sea-Dog Chrome Hasp**

- Cast chrome plated brass
- Uses #6 fasteners
- L: 2-5/16" x W: 1"

SED 222120-1



**Cruiser Draw Pull Catches**

- Electro-polished S/S
- Lockable
- Use #6 fasteners

**Large**

- Base width: 1-5/8"
- Overall length: 3-3/8"

CRU 207-SS-1 Bulk



**Small**

- Base width: 1"
- Overall length: 2-1/2"

CRU 205-SS-1 Bulk



**Perko Hold Down Clamp**

- Chrome plated bronze
- Lockable
- Uses #6 fasteners
- Size: 2-3/4" x 1-3/4"
- Padlock clearance: 1/4"

PER 1108-DP-CHR



**Sea-Dog Chrome Brass Anti-Rattle Fastener**

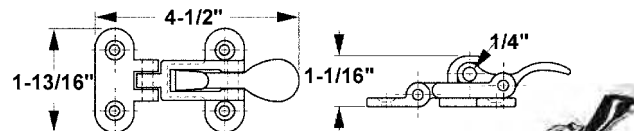

- Sand cast chrome plated brass
- Lockable
- Use #10 fasteners

SED 222110-1



**Perko Table Fastener or Windshield Keeper**

- Chrome plated brass with black plastic knob
- Use #8 fasteners
- Angle length: 1-3/8"
- Angle width: 1"

PER 719-DP-CHR



## Perko Hold-Down Clamps



- Chrome plated bronze
- Uses #8 fasteners

Part #	Description	Length	Width
PER 1112-DP-CHR	Flat Mount	3"	1-1/2"
PER 1113-DP-CHR	Angle Mount	2-1/2"	1-1/2"

## Perko Hatch Fastener

- Chrome plated bronze
- Use #8 fasteners
- Length: 3-1/2". Width 1-5/8"
- Adjustment: 1-1/8"



PER 770-DP-CHR

## Perko Hatch Fastener / Windshield Keeper

- Chrome plated brass and zinc
- Black plastic handle
- Use #8 fasteners
- Base dimensions: 1-1/2" x 5/8"



PER 769-DP-CHR

PER 769-000-99C Spare handle with stud

## Perko Windshield Keeper

- Chrome plated brass and zinc
- Use #8 fasteners
- Bracket: 1-1/2" x 5/8"
- Keeper: 1-1/2" x 3/4"



PER 697-DP-CHR

## Perko Windshield Keeper

- Chrome plated bronze
- Use #8 fasteners
- Bracket: 1-9/16" x 1"
- Keeper: 1-7/8" x 7/8"



PER 967-DP-CHR

## Perko Hatch Fastener

Chrome plated brass with phosphor bronze spring.

- Use #6 fasteners
- Overall length: 3-7/8"
- Mounting base size: 1-1/2" x 9/16"



PER 155-DP-CHR

## Taylor Utility Latch

Rugged black nylon hatch, window, and door fastener. Comes complete with S/S mounting hardware. Blister packed, 2 units per bag.

- Overall length: 2-5/8"
- Width: 1-11/16"
- Adjustment: 1/2"



TAY 551

## Sea-Dog Door Hooks

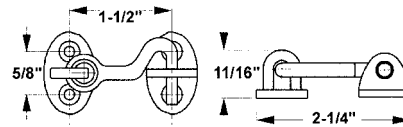

- Made from cast brass
- Use #6 fasteners

SED 222050-1

Chromed brass

SED 222051-1

Brass

## Cruiser Cabin Hook

- Chromed solid hot pressed brass
- Use #6 fasteners



CRU P7070/E-CP 6"

## Perko Cabin Door Hooks

- Chrome plated zinc
- Use #6 fasteners



PER 1199-DP1-CHR 1-3/4"

PER 1199-DP2-CHR 2-1/4"

PER 1199-DP3-CHR 3"

## Cruiser Silent Cabin Hooks

- Solid hot pressed brass
- Use #8 fasteners



Cruiser No.	Length	Finish
CRU P2872/B-PB	2-1/2"	Polished brass
CRU P2872/C-PB	3"	Polished brass
CRU P2872/D-PB	4"	Polished brass
CRU P2872/E-PB	5"	Polished brass
CRU P2872/F-PB	6"	Polished brass
CRU P2872/G-PB	8"	Polished brass
CRU P2872/B-CP	2-1/2"	Chromed brass
CRU P2872/C-CP	3"	Chromed brass
CRU P2872/D-CP	4"	Chromed brass
CRU P2872/E-CP	5"	Chromed brass
CRU P2872/F-CP	6"	Chromed brass
CRU P2872/G-CP	8"	Chromed brass

**Sea-Dog Door Hooks With Swivel**

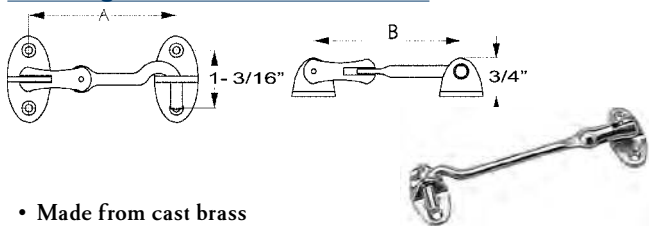

- Made from cast brass
- Use #6 fasteners

Part #	A	B	Material
SED 222080-1	3-1/8"	3"	Chrome
SED 222081-1	3-1/8"	3"	Brass
SED 222085-1	4-1/16"	4"	Chrome
SED 222090-1	5-1/16"	5"	Chrome
SED 222091-1	5-1/16"	5"	Brass

**Sea-Dog S/S Door Hooks**

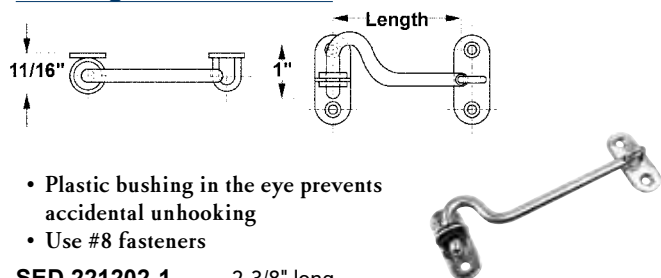

- Plastic bushing in the eye prevents accidental unhooking
- Use #8 fasteners

SED 221202-1	2-3/8" long
SED 221203-1	3" long
SED 221204-1	3-15/16" long

**Sea-Dog Chrome Brass Door Hooks**

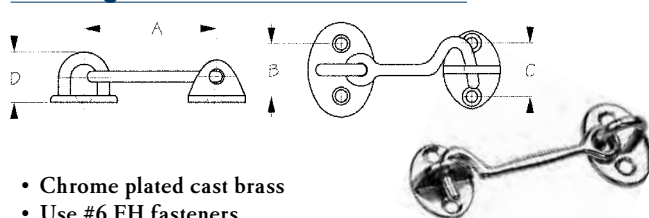

- Chrome plated cast brass
- Use #6 FH fasteners

Part #	A	B	C	D
SED 222112-1	2"	13/16"	13/16"	3/4"
SED 222113-1	2-3/4"	13/16"	13/16"	3/4"

**Lamp S/S Handles**

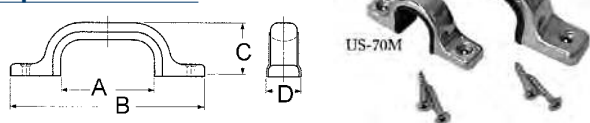

Mirror finish. 304 S/S with synthetic rubber finger grip. Supplied with screws.

Part #	A	B	C	D	Pack
LMP US-70M	20mm	70mm	28mm	17mm	Each
LMP US-160M	88mm	160mm	37.5mm	22mm	Each

**Buck Algonquin Stern Lifting Handle**

- Made of 316 polished S/S
- Base: 1" x 1-3/4"
- Overall: 5-3/4" x 1-3/4"
- Use #10 fasteners



**BUC SLH1**

**Lamp "FT" Series Handles**

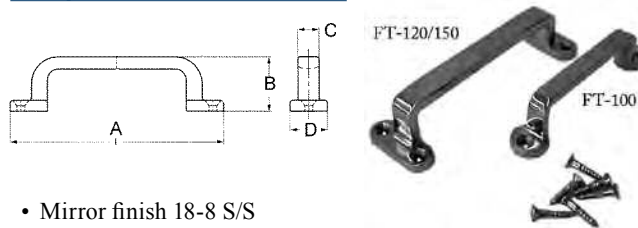

- Mirror finish 18-8 S/S
- Supplied with S/S screws

Part #	A	B	C	D	Pack
LMP FT-100	100mm	25mm	10mm	18mm	pkg
LMP FT-120	120mm	27mm	12mm	36mm	pkg
LMP FT-150	150mm	33mm	15mm	45mm	Bulk

**Perko Handle**

- Chrome plated zinc
- Use #8 fasteners
- Height: 3/4"
- Length: 5-3/4"
- Inside length: 3-5/8"



**PER 1222-DP-CHR (2/pkg)**

**Perko Handle**

- Chrome plated zinc
- Use 1/4" fasteners
- Inside height: 1-5/16"
- Length: 6"
- Inside length: 3-1/2"



**PER 1231-DP-CHR (2/pkg)**

**Perko Chrome Plated Zinc Handle**

- Chrome plated zinc with black plastic
- Use 1/4" fasteners
- Length: 6-1/4"
- Inside height: 1"
- Inside length: 3-1/2"



**PER 1336-DP-CHR 2/pkg**

**Sea-Dog Lift Handle**

- Die cast zinc chrome plated
- Use #10 fasteners
- L: 5-7/8" x W: 2"



**SED 224260-1**

▶ Also See: *Step Handles pg 261*

**Sea-Dog Lift Handles**

- Cast brass
- Use #8 fasteners
- L: 6" x W: 1-7/8"

SED 222355-1 Chrome  
 SED 222356-1 Brass



**Sea-Dog Lift Handle**

- Chrome plated brass
- Use #10 fasteners
- L: 4-3/4" x W: 1-1/4"

SED 222340-1



**Sea-Dog Deluxe Lift Handles**

- Cast brass

No.	L	W	Material	Fastener
SED 222345-1	4"	1"	Chrome	#8 FH
SED 222346-1	4"	1"	Brass	#8 FH
SED 222348-1	6"	1-5/16"	Chrome	#10 FH
SED 222349-1	6"	1-5/16"	Brass	#10 FH



**Sea-Dog Lift Handle**

- Chrome plated brass
- Use #8 fasteners
- L: 5-3/4" x W: 1-3/4"

SED 222350-1



**Lamp FS Series Knob**

- Brushed aluminum & black synthetic rubber
- Supplied with screws
- L: 50mm x H: 27mm

LMP FS-04S Bulk



**Sea-Dog Flush Pulls**

- Injection molded Delrin
- Use #6 fasteners
- L: 3-5/8" x H: 2-3/8" x D: 5/8"

SED 227320-1 Black  
 SED 227321-1 White  
 SED 227322 Grey



**Perko Flush Pull**

- Chrome plated zinc
- Uses #6 fasteners
- Size: 3-11/16" x 1-11/16"
- Depth: 7/16"

PER 1110-DP-CHR



**Perko Drawer Pull**

- Chrome plated zinc
- Uses #6 fasteners
- Outside width: 3-7/16"
- Inside width: 2-5/16"

PER 958-DP-CHR



**Sea-Dog Delrin Flush Pulls**

- Injection molded Delrin
- Use #6 fasteners
- L x W: 1-5/8" x D: 5/8"

SED 227310-1 Black  
 SED 227311-1 White



**Sea-Dog S/S Ladder Hinge**

- Cast 316 S/S
- Highly polished finish
- L: 6-11/16" x W: 3/4"
- Use #10 fasteners

SED 205290-1 2/pkg



**Sea-Dog Strap Hinges**

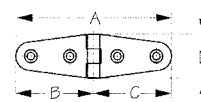

- Polished cast brass
- 2 per/pack

Part #	A	B	C	D	E	Fastener
SED 204391-1	4"	2"	2"	1-1/16"	3/16"	#8 FH
SED 204401-1	6"	3"	3"	1-5/16"	3/16"	#10 FH



**Perko Strap Hinges**

- Chrome plated bronze
- 2 per/pack
- Use #10 fasteners

Part #	Length	Pin Width
PER 120-DP1-CHR	4"	1-1/8"
PER 120-DP2-CHR	6"	1-1/8"



**Sea-Dog Strap Hinge**

- Chrome plated sand cast brass
- Use #8 fasteners
- L: 5-5/8" x W: 1-1/16"

SED 204400-1



**Sea-Dog Heavy Duty S/S Strap Hinge**

- Stamped 304 S/S
- L: 7-1/8" x W: 1-5/8"
- Display packaged

SED 201620-1 2/pkg



Sea-Dog S/S Strap Hinges

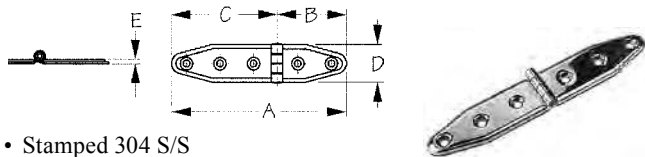

- Stamped 304 S/S
- 2 per/pack
- Use #8 fasteners

Part #	A	B	C	D	E
SED 201134-1	4"	2"	2"	1-1/8"	1/8"
SED 201135-1	5-1/16"	2-1/32"	3-1/32"	1-1/8"	1/8"
SED 201136-1	6-1/8"	3-1/16"	3-1/16"	1-1/8"	1/8"

Sea-Dog S/S Strap Hinges

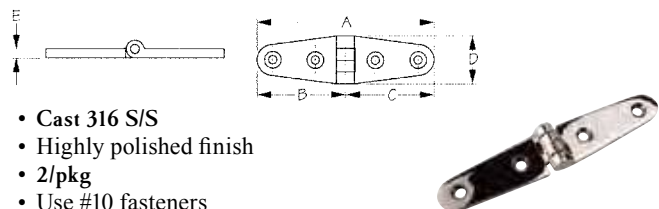

- Cast 316 S/S
- Highly polished finish
- 2/pkg
- Use #10 fasteners

Part #	A	B	C	D	E
SED 205390-1	4-1/8"	2-1/16"	2-1/16"	1"	3/16"
SED 205400-1	5-7/8"	2-15/16"	2-15/16"	1-1/8"	3/16"

Sea-Dog S/S Butt Hinges

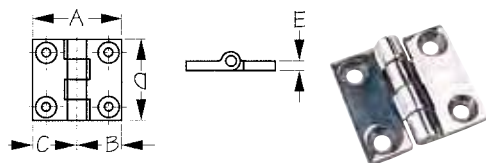

- Cast 316 S/S
- Use #10 fasteners

Part #	A	B	C	D	E	Pack
SED 205140	1-5/8"	13/16"	13/16"	1-1/2"	3/16"	Each
SED 205140-1	1-5/8"	13/16"	13/16"	1-1/2"	3/16"	2
SED 205142-1	2"	1"	1"	2"	3/16"	2

Sea-Dog S/S Butt Hinges

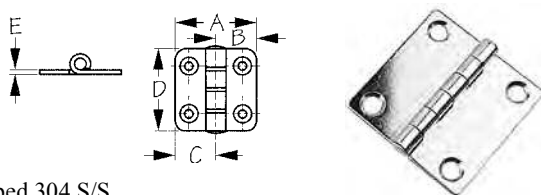

- Stamped 304 S/S
- Use #8 fasteners

Part #	A	B	C	D	E	Pack
SED 201580	1-3/8"	11/16"	11/16"	1-1/2"	1/16"	Each
SED 201580-1	1-3/8"	11/16"	11/16"	1-1/2"	1/16"	2
SED 201582-1	2"	1"	1"	2"	1/16"	2

Sea-Dog S/S Butt Hinges

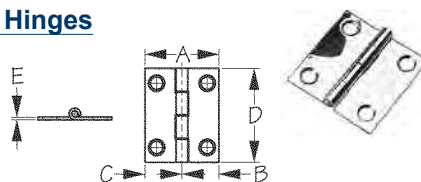

- Stamped 304 S/S
- 2/pkg
- Use #6 fasteners

Part #	A	B	C	D	E
SED 201070-1	1-1/4"	5/8"	5/8"	1-1/2"	1.2mm
SED 201071-1	1-5/8"	13/16"	13/16"	2"	1.2mm
SED 201072-1	2"	1"	1"	2"	1.5mm

Sea-Dog S/S Butt Hinge

- Stamped 304 S/S hinge
- Uses #8 fasteners
- L: 3" x W:2"

SED 201080-1 2/pkg

Sea-Dog Heavy Duty S/S Butt Hinges

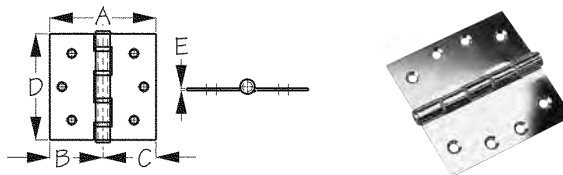

Stamped 304 S/S hinge. Hole patterns on these hinges correspond to ANSI/BHMA 156.7-1988 standards for use in the most demanding applications.

- Use #12 fasteners

Part #	A	B	C	D	E	Pack
SED 201236-1	4-1/2"	2-1/4"	2-1/4"	4-1/2"	1/8"	2
SED 201237	5"	2-1/2"	2-1/2"	5"	1/8"	Each

Sea-Dog S/S Heavy Duty Hinges - Top Pin

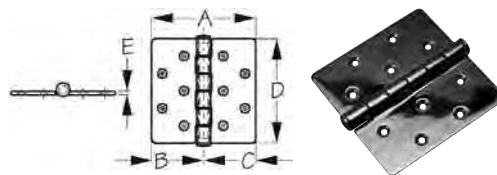

Investment cast 316 S/S construction. Designed for applications where extra strength and corrosion resistance are required. Features silent movement and no rattle due to integral nylon bearings.

- Use 1/4" fasteners

Part #	A	B	C	D	E
SED 205225	4"	2"	2"	4-1/2"	3/16"
SED 205227	5-1/2"	2-3/4"	2-3/4"	4-1/2"	3/16"

**Sea-Dog S/S Heavy Duty Hinges - Centre Pin**

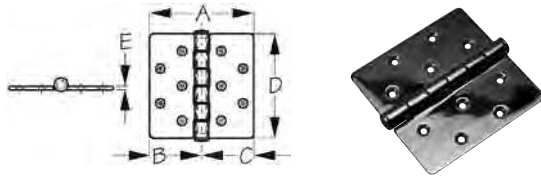

Investment cast 316 S/S construction. Designed for applications where extra strength and corrosion resistance are required. Features silent movement and no rattle due to integral nylon bearings. Hinge folds flat.

- Use 1/4" fasteners

Part #	A	B	C	D	E
SED 205235	4"	2"	2"	4-1/2"	3/16"
SED 205237	5-1/2"	2-3/4"	2-3/4"	4-1/2"	3/16"
SED 205238	6"	3"	3"	6"	3/16"

**Sea-Dog S/S Short Side Door Hinges**

- Stamped 304 S/S
- Uses #8 fasteners
- L: 2" x W:1-1/2"

SED 201020-1 2/pkg  
 SED 201020 Each



**Cruiser Brass & Chrome Plated Butt Hinges**

Heavy duty extruded brass with brass pin. Available in plain brass or chrome plated finish.

- Sold by each

Brass	Screw
CRU SC 1-1/2"x1-1/2"	#4
CRU SC 2-1/2"x1-1/2"	#8
CRU SC 3"x2-1/2"	#8
CRU SC 3"x3"	#8
Chrome	
CRU PC 2-1/2"x1-1/2"	#8
CRU PC 3"x3"	#8



**Perko Butt Hinge**

- Chrome plated zinc butt hinge
- Has removable pin
- Uses #8 fasteners
- 2" x 2"

PER 1293-DP4-CHR



**Sea-Dog S/S Offset Butt Hinge**

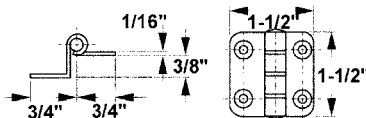

- Stamped 304 S/S
- Formed with a 3/8" offset for front surface of a raised door
- Use #8 fasteners

SED 201590-1 2/pkg

**Cruiser Nylon Butt Hinges**

- Natural nylon with a S/S pin
- Each

CRU 1202 2-1/2" 2-1/2" x 1-11/16", #6 screw  
 CRU 1202 3"PK 3" x 1-15/16", #6 screw  
 CRU 1202 4"PK 4" x 2-3/8", #8 screw



**Sea-Dog S/S Hatch Hinges**

- Cast 316 S/S
- Use #10 fasteners
- L: 3-1/2" x W: 2-7/8"

SED 205285 Bulk, each  
 SED 205285-1 Packaged, each



**Sea-Dog Hatch Hinge**

- Chrome plated brass
- Use #10 fasteners
- L: 3" x W: 2-1/2"

SED 204280-1 1/pkg



**Sea-Dog S/S Hatch Hinge**

- Cast 316 S/S
- Use #10 fasteners
- L: 2-7/8" x W: 2-5/8"

SED 205280-1 Each



**Sea-Dog S/S Take-Apart Hinges**

- Cast 316 S/S
- Use #10 fasteners
- L: 3-1/2" x W: 2"

SED 205270-1 Left hand, 2/pkg  
 SED 205275-1 Right hand, 2/pkg



**Sea-Dog S/S Locking Take-Apart Hinge**

- Investment cast 316 S/S
- L: 3-1/2" x W: 2"
- Use #10 fasteners

SED 205276 Each



**Sea-Dog Take-Apart Hinges**

- Forged chrome plated brass
- Use #10 fasteners
- L: 3-7/8" x W: 2"

SED 204278-1 Left hand, 2/pkg  
 SED 204279-1 Right hand, 2/pkg



**Sea-Dog S/S Door Hinge**

- Stamped 304 S/S
- Uses #8 fasteners
- L: 2-3/4" x W: 1-1/2"

**SED 201030-1** 2/pkg

Hinge mounting pad used on door hinge part number 201030. Thickness: 3/16".

**SED 201039** Pad



**Sea-Dog S/S Flush Door Hinge**

- Stamped S/S flush door hinge
- Use #8 fasteners
- L: 2-7/8" x W: 1-1/2"

**SED 201535-1** 2/pkg



**Sea-Dog S/S Flush 2-Pin Hinge**

- Stamped 304 S/S hinge
- Use #6 fasteners
- L: 3-1/4" x W: 1-3/16"

**SED 201550-1** 2/pkg



**Sea-Dog S/S Flush 2-Pin Hinge**

- Stamped 304 S/S hinge
- Use #8 fasteners
- L: 3" x W: 1-1/2"

**SED 201551-1** 2/pkg



**Sea-Dog S/S Round Side Hinge**

- Stamped 304 S/S
- Use #8 fasteners
- L: 2-3/4" x W: 1-1/2"

**SED 201700-1** 2/pkg



**Sea-Dog S/S Door Hinges**

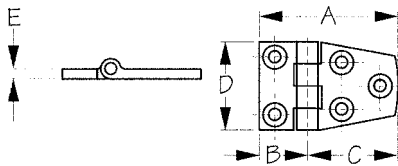

Cast 316 S/S, highly polished finish. 2/pkg.

- Uses #10 fasteners

Part #	A	B	C	D	E
<b>SED 205310-1</b>	2-3/8"	7/8"	1-1/2"	1-1/2"	3/16"
<b>SED 205320-1</b>	2-7/8"	3/4"	2-1/8"	1-1/2"	3/16"

**Sea-Dog S/S Cuddy Door Hinges**

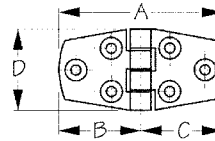

- Cast 316 S/S, highly polished finish
- Uses #10 fasteners

Part #	A	B	C	D	Pack
<b>SED 205410</b>	3"	1-1/2"	1-1/2"	1-1/2"	Each
<b>SED 205410-1</b>	3"	1-1/2"	1-1/2"	1-1/2"	Pair
<b>SED 205420-1</b>	4-1/8"	2-1/16"	2-1/16"	1-1/2"	Pair

-1 Suffix packaged.

**Sea-Dog S/S Door Hinge**

- Stamped 304 S/S
- L: 2-7/8" x W: 1-1/2"
- Use #8 fasteners

**SED 201530-1** 2/pkg



**Sea-Dog S/S Door Hinges**

- Stamped 304 S/S
- Use #8 fasteners
- L: 2-1/8" x W: 1-1/2"

**SED 201510** Bulk each  
**SED 201510-1** 2/pkg



**Sea-Dog S/S Round Hinge**

- Cast 316 S/S
- Highly polished finish
- Uses #10 fasteners
- L: 3-1/4" x W: 1-3/16"

**SED 205460** Each



**Sea-Dog S/S Offset Hinge**

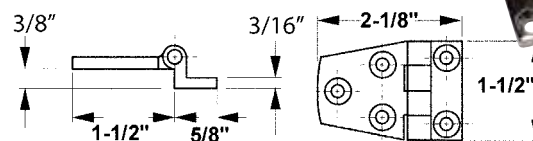

Investment cast 316 S/S. The hinge is formed with a 3/8" offset. The hinge is designed to be mounted on the front surface of a raised door.

- Use #10 fasteners

**SED 205350-1** 2/pkg

**Sea-Dog S/S Cuddy Hinge**

- S/S hinge
- Use #8 fasteners
- L: 3" x W: 1-9/16"

**SED 201600-1** 2/pkg



**Sea-Dog S/S Long Side Door Hinge**

- Stamped 304 S/S
- Use #10 fasteners
- L: 6" x W: 2-1/4"



SED 201750-1 2/pkg

**Sea-Dog S/S Flush Mount Concealed Hinges**

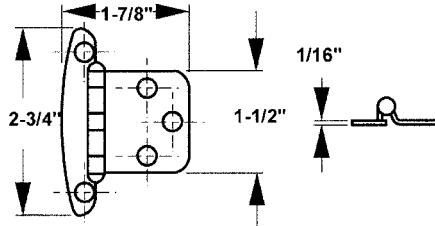

- Stamped 304 S/S/ or polished brass
- Use #6 fasteners



SED 201954-1 S/S, 2/pkg  
 SED 201955-1 Brass, 2/pkg

**Sea-Dog S/S Semi-Concealed Hinges**

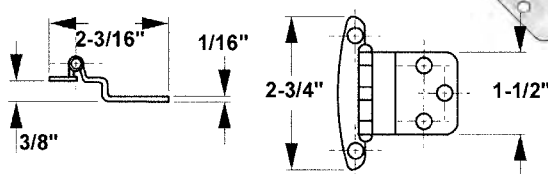

- Stamped 304 S/S or polished brass
- Use #6 fasteners

SED 201914 S/S, bulk each  
 SED 201914-1 S/S, 2/pkg  
 SED 201915-1 Brass, 2/pkg

**Perko Hinge**

- Chrome plated zinc
- 3/8" offset
- 2/pkg
- Use #8 fasteners



Part #	Size Open	Offset
PER 942-DP-CHR	1-1/2" x 1-1/2"	3/8"

**Sea-Dog Short Side Door Hinges**

- Injection molded fibreglass nylon
- S/S hinge pin
- Use #8 fasteners
- L: 2-1/4" x W: 1-3/8"



SED 202510-1 Black, 2/pkg  
 SED 202511-1 White, 2/pkg

**Sea-Dog Nylon Butt Hinges**

- Injection molded fibreglass nylon
- L: 1-1/2" x W: 1-3/8"
- Use #8 fasteners



SED 202580-1 Black, 2/pkg  
 SED 202581-1 White, 2/pkg

**Sea-Dog Nylon Door Hinges**

- Injection molded fibreglass nylon
- Use #8 fasteners
- L: 3" x W: 1-3/8"



SED 202530-1 Black, 2/pkg  
 SED 202531-1 White, 2/pkg

**Sea-Dog Door Hinge**

- Die cast chrome zinc
- L: 2-7/8" x W: 1-1/2"
- Use #8 fasteners



SED 206530-1 2/pkg

**Perko Inset Cupboard Hinge**

- Chrome plated brass
- 2/pkg
- Use #4 fasteners
- 3/8" inset
- Size: 2-3/4" x 2-1/8"



PER 271-DP-CHR

**Perko Non-Mortised Hinge**

- Chrome plated brass
- 2/pkg
- Use #8 fasteners
- Pin height: 3-3/8"
- Width closed: 7/8"



PER 957-DP-CHR

**Lamp S/S Hinge**

- Mirror finish 18-8 S/S
- Use #6 fasteners
- L: 127mm x W: 38.1mm

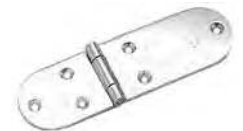

LMP MA-5 2/pkg

**Lamp Table Hinge**

- Chromed brass table hinge
- Use #8 fasteners
- L: 70mm x W: 40mm

LMP SMH-40CR Each

**Lamp S/S Hinge**

- Satin finish 18-8 S/S
- Use #8 fasteners
- L: 81mm x W: 30mm

LMP SMH-83S Bulk

**Lamp Table Hinges**

- Solid brass
- Sold by the each
- Use #8 fasteners
- L: 70mm x W: 30mm

LMP SMH-30CR Chrome finished

LMP SMH-30PB Polished finish

**Perko Cuddy Door Hinges**

- Chrome plated bronze
- 2/pkg

Part #	Length	Width	Screw
PER 951-DP1-CHR	3"	1-1/2"	#8
PER 951-DP2-CHR	4"	1-1/2"	#8

**Perko Cuddy Door Hinge**

- Chrome plated zinc
- 2/pkg

Part #	Length	Width	Screw
PER 808-DP-CHR	3"	1-1/2"	#8

**Perko "T" Hinges**

- Chrome plated
- 2/pkg
- Use #10 fasteners

Part #	Length	Width	Height 'T' side
PER 197-DP1-CHR	4"	2-1/8"	1-5/16"
PER 197-DP2-CHR	6"	3"	1-1/2"

**Perko Door Hinge**

- Chrome plated brass
- 2/pkg
- Use #6 fasteners

Part #	Length	Width
PER 924-DP-CHR	3"	1-1/2"

**Perko Door Hinge**

- Chrome plated bronze
- 2/pkg

Part #	Width Open	Width Short side	Height Pin	Screw
PER 999-DP-CHR	3-1/2"	1-1/2"	1-1/2"	#8

**Perko Door Hinges**

- Chrome plated bronze or chrome plated zinc
- 2/pkg
- Use #8 fasteners

Part #	Length	Width	Material
PER 987-DP1-CHR	2-1/2"	1-1/2"	Chrome bronze
PER 1213-DP1-CHR	2-1/2"	1-1/2"	Chrome zinc

**Perko Offset Door Hinges**

- Chrome plated bronze
- 3/8" offset
- 2/pkg
- Use #8 fasteners

Part #	Width Open	Width Short side	Height Pin
PER 988-DP1-CHR	2-1/4"	1-1/2"	3/4"
PER 988-DP2-CHR	2-3/4"	1-1/2"	3/4"

**Perko Hinge**

- Chrome plated zinc
- 2/pkg
- Use #8 fasteners

Part #	Size Open
PER 941-DP-CHR	1-1/2" x 1-1/2"

**Sea-Dog S/S Locker Hinge**

- Stamped 304 S/S locker hinge
- Use #6 fasteners
- L: 6" x W: 2-15/16"

SED 201805-1 2/pkg



**Lamp Concealed Hinges**

- S/S self-closing
- 19mm coverage with 100° opening
- Come with 304 S/S screws



**Hinge only**

**LMP 304B-C46/19** Bulk each

**Mounting plate only**

**LMP 304B-P4A/32** Bulk each

**Lamp Concealed Hinges**

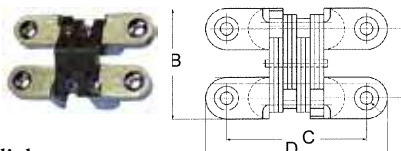

Zinc alloy body and S/S link.

Part #	A	B	C	D
<b>LMP R-43</b>	18mm	29mm	32mm	43mm
<b>LMP R-60</b>	22.2mm	35.2mm	47mm	60mm

**S/S Piano Hinge**

Quality hinge sold in 6 foot lengths. Please note that size given refers to the hinge when opened. Approximately 48 screws per length needed.

- Use #6 fasteners
- LAR 1-1/4" x 6'SS**
- LAR 1-1/2" x 6'SS**
- LAR 2" x 6'SS**
- LAR 3" x 6'SS**

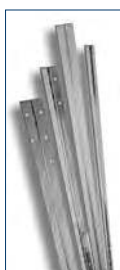

**Sea-Dog S/S Piano Hinge**

- 304 S/S
- Use #6 fasteners
- 1-1/4" wide (open) x L: 36"

**SED 201850**

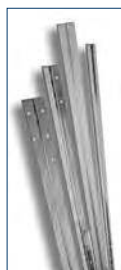

**Cruiser Aluminum Coat Hook**

- Anodized aluminum
- H: 4-3/4" x W: 3/4" x D: 1-1/2"
- Use #6 fasteners

**CRU 251**



**Lamp Hardware Towel Rack**

- Material: 303 S/S
- Finish: Mirror
- Supplied with S/S screws



Part #	Length	Depth	Tube
<b>LMP KBT-350</b>	350mm	50mm	10mm
<b>LMP KBT-450</b>	450mm	50mm	10mm

**Sea-Dog Single Coat Hooks**

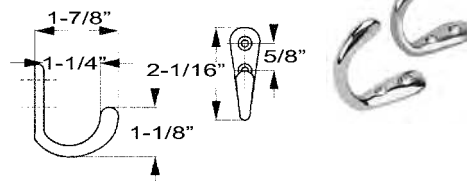

- Cast brass
- Display packaged (2/pkg)
- Use #6 fasteners

**SED 671500-1** Chromed  
**SED 671505-1** Brass

**Sea-Dog Single Coat Hooks**

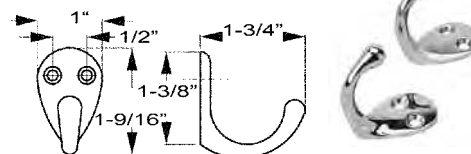

- Cast brass
- Display packaged (2/pkg)
- Use #6 fasteners

**SED 671501-1** Chromed  
**SED 671506-1** Brass

**Sea-Dog Triple Coat Hooks**

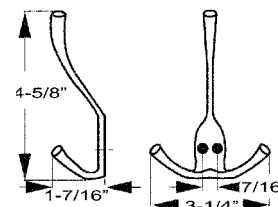

- Cast brass
- Display packaged
- Use #6 fasteners

**SED 671520-1** Chrome  
**SED 671525-1** Brass

**Cruiser Polished Brass Hat & Coat Hook**

- Cast brass, polished finish
- H: 5" x W: 1-1/4" x D: 3"
- Use #6 fasteners

**CRU P3159-PB** Polished brass



**Cruiser Polished Brass Single Wardrobe Hook**

- Cast brass, polished finish
- H: 2-1/16" x W: 3/4" x D: 1-7/8"
- Use #6 fasteners

**CRU P2349-PB**



**Perko Hat & Coat Hook**



- Chrome plated zinc
- Use #6 fasteners

No.	Depth	Width
PER 975-DP1-CHR	2"	1-1/8"
PER 975-DP2-CHR	3"	1-1/4"

**Perko Coat Hook**



- Chrome plated zinc
- Use #6 fasteners
- Projection: 1-3/8"
- Width: 1-1/8"

PER 610-DP-CHR

**Sea-Dog S/S Coat Hook**

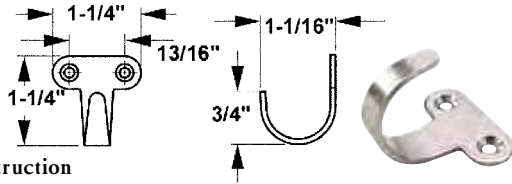

- S/S construction
- Use #6 fasteners

SED 671465-1 2/pkg

**Perko Double Coat Hook**



- Chrome plated zinc
- Use #6 fasteners
- Projection: 3/4"
- Base width: 1"

PER 1106-DP-CHR

**Perko Utility Hook**



- Chrome plated zinc
- 1/4" inside hook
- Use #6 fasteners
- L: 15/16" L x W: 1/2"

PER 1249-DP-CHR 5/pkg

**Sea-Dog Nylon Coat Hook**



- Black
- Uses #8 fasteners

SED 672709-1 2/pkg

**Lamp S/S Hooks**

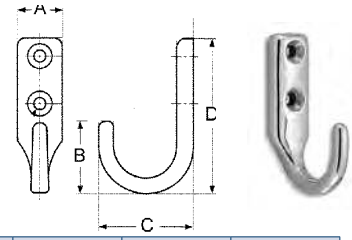

- Comes with screws
- Bulk packaged

Part #	A	B	C	D
LMP EL-25	12mm	19mm	26mm	40mm
LMP EL-30	16mm	25mm	32mm	54.5mm

**Lamp S/S Hooks**

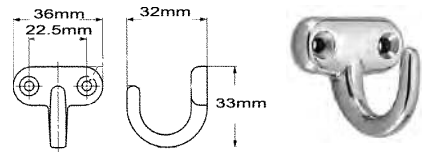

- Comes with screws
- Bulk packaged

LMP EP-40

**Lamp S/S Hooks**

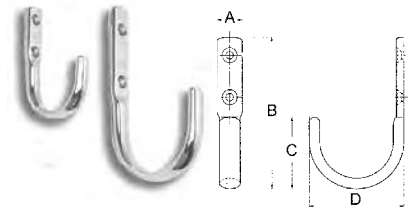

- Polished S/S
- Comes with screws

Part #	A	B	C	D	Pack
LMP JF-45	12mm	72mm	34mm	45mm	Bulk
LMP JF-70	16mm	120mm	55mm	68mm	Bulk

**Lamp S/S Ball Point Hooks**



- Polished 18-8 S/S
- Sold by each

LMP TL-15	21/32"
LMP TL-20	29/32"
LMP TL-30	1-1/4"
LMP TL-40	1-19/32"

**S&J Solid Brass Cup Hooks**



- Hang your cups.

Part #	Size	Pack
S&J 480011	1/2"	8
S&J 480021	5/8"	7
S&J 480031	3/4"	7
S&J 480041	7/8"	6
S&J 480051	1"	5

**Sea-Dog Nylon Lashing Hooks**

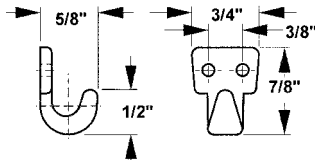

- Injection molded nylon
- Use #4 fasteners

**SED 671420-1** 5/pkg black  
**SED 671421-1** 5/pkg white

**Sea-Dog S/S Hammock Hooks**

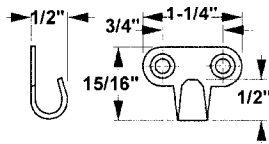

- Stamped 304 S/S
- Use #6 fasteners

**SED 671460** Bulk, each  
**SED 671460-1** 2/pkg

**Lamp Aluminum Shelf Brackets**

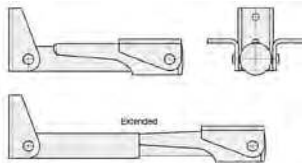

For propping up cabinet doors or shelves. Made from aluminum and matte finished.

**LMP 38830-25** 6.6" to 10.8", max. load 121 lbs  
**LMP 38845-25** 10" to 17", max. load 132 lbs

**Gemlux Folding Bracket**

304 S/S locking folding bracket will hold a maximum 600 lbs static weight.

- Height: 11-7/8"
- Maximum width: 1-1/4"
- Protrudes: 6-1/2" in the open position

**GEM 3301468**



**Lamp Angle Brackets**

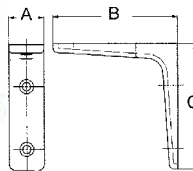

- Polished solid brass
- Supplied with brass screws

Part #	A	B	C
<b>LMP BA-35</b>	14mm	35mm	35mm
<b>LMP BA-45</b>	15mm	45mm	45mm
<b>LMP BA-60</b>	17mm	60mm	60mm
<b>LMP BA-80</b>	19mm	80mm	80mm

**Lamp S/S Angle Brackets**

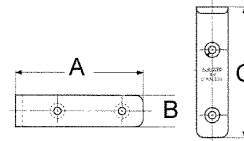

- Mirror finish 18-8 S/S
- Supplied with S/S screws

Part #	A	B	C	Pack
<b>LMP SU-30M</b>	31mm	12mm	31mm	Bulk
<b>LMP SU-45M</b>	46mm	13mm	46mm	Bulk
<b>LMP SU-60M</b>	61mm	15mm	61mm	Bulk

**Perko Spring Clamps**

- Polished S/S
- Use #6 fasteners
- Sold in pairs

**PER 502-DP1-ST5** 5/8" to 1-1/4"  
**PER 502-DP2-ST5** 1" to 1-3/4"



**Sea-Dog S/S Boat Hook Brackets**

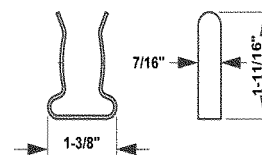

- Stamped 304 S/S
- Use #4 fasteners
- Fits up to 3/4" to 1" pole

**SED 491135-1** 2/pkg

**Beckson Clipmate Holding Clips**

Unique design and tempered B-Flex plastic material make Clipmate holding clips the perfect way to hold brooms, pumps, flashlights, tools, blueprint tubes and other round objects neatly in place. The design provides permanent holding spring action unlike metal or other plastic clips, which ultimately become fatigued. Corrosion is nonexistent. Sold in pairs. Require a #6 pan head fastener. White.



**BEC CM-1** 7/8"-1-1/8"  
**BEC CM-2** 1-1/2" - 2"

### Beckson Plastic Holding Clips

These attractive plastic clips solve your holding needs. Ideal for storing boat hooks, gaffs, mops, flashlights, pumps, tools and a variety of accessories. These clips are non-conductive, non-magnetic and non-corrosive making them perfect for indoor or outdoor use. Discover hundreds of uses to organize tools, materials, accessories and parts onto your equipment. 1/8" holes on 3/4" centre for all sizes. CLP clips require a #6 flat head fastener.

Sold in pairs.



Part #	Colour	Size Range
BEC CLP-1/4	Black	1/4" - 5/16"
BEC CLP-1/4W	White	1/4" - 5/16"
BEC CLP-1/2	Black	3/8" - 1/2"
BEC CLP-1/2W	White	3/8" - 1/2"
BEC CLP-3/4	Black	5/8" - 7/8"
BEC CLP-3/4W	White	5/8" - 7/8"
BEC CLP-1	Black	7/8" - 1-1/8"
BEC CLP-1W	White	7/8" - 1-1/8"
BEC CLP-11/4	Black	1-1/8" - 1-3/8"
BEC CLP-11/4W	White	1-1/8" - 1-3/8"
BEC CLP-11/2	Black	1-3/8" - 1-5/8"
BEC CLP-11/2W	White	1-3/8" - 1-5/8"
BEC CLP-13/4	Black	1-5/8" - 1-7/8"
BEC CLP-13/4W	White	1-5/8" - 1-7/8"
BEC CLP-2	Black	1-7/8" - 2-1/8"
BEC CLP-2W	White	1-7/8" - 2-1/8"

### Sea-Dog S/S Boat Hook Brackets

- Stamped 304 S/S
- Fits up to 1-1/4" pole
- Use 1/4" fasteners
- 4" H x 1" W

SED 491130-1 2/pkg



### Perko Boat Hook Holder

- Polished S/S
- Maximum pole size 1-1/2"
- Use #8 fasteners

PER 492-DP-ST 2/pkg



### Perko Pole Storage Clips

- Soft black rubber
- Fits 3/4" diameter tubing
- Use #10 PH screws

PER 477-DP-BLK 2/pkg



### Sea-Dog Pole Storage Clip

- Injection molded black rubber
- Accepts to 3/4" dia. pole

SED 491145-1



### Sea-Dog Boat Hook Brackets

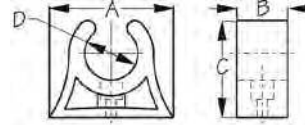

- Injection molded rubber
- Sold in pairs

Part #	A	B	C	D	Pole Size
SED 491341-1	1-1/4"	7/16"	15/16"	1/2"	1/2"
SED 491343-1	1-1/2"	7/16"	1-1/16"	5/8"	5/8"
SED 491345-1	1-3/4"	3/4"	1-1/4"	3/4"	3/4"
SED 491347-1	1-16/16"	13/16"	1-1/2"	7/8"	7/8"
SED 491349-1	2-1/4"	3/4"	1-5/8"	1"	1"
SED 491351-1	2-15/16"	3/4"	2-1/8"	1-1/4"	1-1/4"
SED 491353-1	3-5/16"	3/4"	3-5/16"	1-1/2"	1-1/2"

### Garelick Utility Mounting Clip

Made of hardened spring steel. Rust proof plated and plastic coated. Holds from 3/4" to 1-1/4" diameter.

GAR 75015 2/pkg



### Davis Quick Fist Rubber Clamp

Ideal for stowing or transporting tools and holding equipment firmly in place. Use as a pipe stand-off. Manufactured from heavy duty, transportation grade rubber. UV resistant and withstands extreme heat and cold.

- Mounts with one #10 bolt or screw
- Will hold objects from 7/8" to 2-1/4" diameter
- Approximate capacity is 22 lbs each
- Mounting base: 7/8" x 2-3/4"

DIN 540 Pair

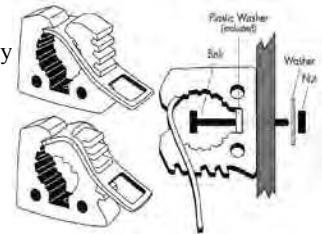

### Davis Super Quick Fist Rubber Clamp

Ideal for stowing or transporting fire extinguishers, cylinders and chart tubes. Manufactured from heavy duty, transportation grade rubber. UV resistant and withstands extreme heat and cold.

- Mounts with 3 #10 bolt or screw
- Will hold objects from 2-1/2" to 7-1/2" diameter
- Approximate capacity is 50 lbs each
- Mounting base: 7/8" x 6"

DIN 544 Each



**Caframo Complete Drying Station**

Dries boots, shoes or gloves, 365 days a year, Includes built in tray with glove dryers, Keeps water and mess on tray instead of floor

- Digital Control: Bright LED display
- Simple touch control
- 15 minute warm-to-wear setting
- Up to 8 hours of drying time
- Grooves in tray to hold skates upright for quick and easy drying
- Fully portable
- CSA approved to US and Canadian standards
- Safe for use on all footwear materials
- 120 AC Volts, 60HZ – 300 watts
- One year warranty



**CAF 7801CA-GBX**

**Caframo Mini Heater/Defroster**

12 volt DC. 100 watts. 340 BTU's/HR. Power consumption: 8.3 amps at 12 volts DC input. Genuine PTC ceramic element. Instant heat, defrosts windows and warms hands and feet, safely. Comes with lighter plug adapter and 5' lead wire.

- 4" H x 6-1/2" W x 2-3/4" D



**CAF 9303**

**Caframo Ultimate Fan**

12 volt DC fan. 0.59 amps. Compact design. Blade made of soft white plastic. Plastic housing. Pivots up and down and swivels sideways. Comes with two mounting bases, sure grip suction cup and permanent screw down base. One year conditional warranty.

- 7" high, 6' cord



**CAF 747DC-WCS** White  
**CAF 747DC-BCS** Black

Same as 747 except permanent screw down base, no plug, ready to wire in.

**CAF 757DC-WBX** White

Parts:

**CAF 747-01WBG** Fan blade only

**Caframo Minimax Fan**

Battery powered portable fan. Uses 4 - 1.5V "D" size batteries (not included). Black plastic blade and housing. Variable speed control. One year limited warranty.

- 5-1/2" x 5-1/2" x 3-1/2"
- Blade diameter: 4-1/2"



**CAF 737DX-BCS**

**Caframo Tiny Tornado II**

- Compact high performance
- Seven position head, combined with suction cup and clip
- Uses one 'D' size battery
- Moves up to 100 CFM
- One year warranty



**CAF 827CA-TCS** Charcoal

**Caframo Chinook AC Fan**

- 7" 'finger-safe' soft plastic blade
- Airflow is not blocked by a grill making this fan aerodynamically superior to much larger grilled fans
- Two speed, 120V AC, 60 HZ
- High 210 CFM, low 138 CFM
- Two year warranty



**CAF 707CH-WBX** White

**Sea-Dog Clamp-On Fan**

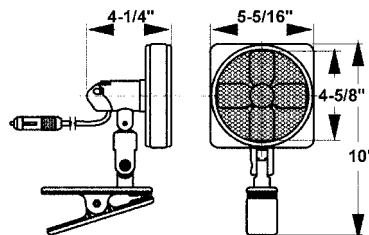

Black ABS housing, clam packed. Clamp on mount fan. Comes with a 6 ft. cord and plugs into a 12V power socket. Integral high/low speed switch included.

**SED 450110-1**

**Sea-Dog 12V Fan**

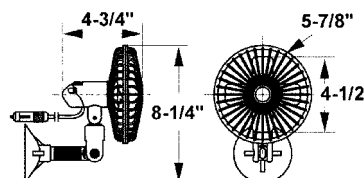

Black ABS housing, clam packed. Suction cup mount fan. Comes with a 6 ft. cord and plugs into a 12 volt power socket. Integral high/low speed switch included.

**SED 450120-1**

**Sea-Dog Fan & Heater**

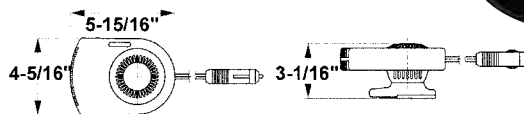

Black ABS housing, clam packed. Ceramic heater. Great for keeping small windows clear. Comes with a 5-1/2 ft. cord that plugs into a 12 volt power socket. Base pivots and rotates and can be attached with Velcro strips.

**SED 450150-1** 150 Watts

### Guest Stow-Away Fan

- Installation hardware included
- Built-in on/off switch
- Mount on wall, ceiling or dash
- Rotating louver directs air flow
- Fan folds out of the way when not in use
- 12V, 0.8 Amps
- Light grey
- Dimensions: W: 5-1/2' x H: 6-3/4" x D: 1-3/4"
- One year warranty

**GUE 902**

### Caframo Ecofan

- For use on stoves with a surface temperature between 300°F & 650°F (150°C & 340°C)
- Generates its own electricity using the heat of the stove
- 100 CFM output
- Fan speed varies with the stove temperature
- Ultra quiet
- W: 4" x L: 3" x H:9"
- One year warranty

**CAF 800CA-BBX**

### Caframo Ecofan Airplus

- For use on stoves with a surface temperature between 300°F & 650°F (150°C & 340°C)
- 150 CFM output
- Dual heat controllers in the base to help prevent overheating
- 9" tri-blade delivers broad range of warm air
- W: 4" x L: 3" x H:9"
- One year warranty

**CAF 802CA-BBX**

### Caframo Ecofan GS

- For use on stoves with a surface temperature between 150°F & 300°F (65°C & 150°C).
- 150 CFM output
- Starts automatically and adjusts its speed with the surface temperature
- W: 6.5" x L: 2.5" x H:6"
- One year warranty

**CAF 806GS-BBX**

### Caframo Bora 12V Fan

- Touch controls
- Full grills on both front and back
- 3 speeds
- Built in handle for easy positioning
- Fan can be swivelled side to side as well as up and down
- Long-life motor 5000+ hour
- Blade 5"
- Draw: 0.19 amps on high
- Dim: 9" H x 6.25"W x 3.625" D
- Material: UV FR ABS



**CAF 748CA-BBX**      Black  
**CAF 748CA-WBX**      White

### Caframo Sirocco Premium 12V Fan

- Limitless positioning, the unique Gimbal design allows full 360 degree rotation
- Stows flat and compact when not in use
- Ultra low current, draws only 0.4 amps
- Battery saver timer shuts fan off in two hour increments.
- If voltage should drop below 10.5 volts fan will not operate.
- Quiet operation
- Finger safe blade
- 3 speeds
- 10" diameter
- Two year warranty



**CAF 807CA-WBX**      White  
**CAF 807CA-BBX**      Black

### Caframo Camano 12V Fan

- Single speed fan designed for quiet operation
- Touch control on face of fan
- Locking flex-mount ensures easy positioning and stowing
- Fully guarded on back for greater safety
- 2000+ hour motor
- Installation: Direct wire to 3 amp circuit
- Draw: 0.34 amps
- Blade: 5"
- Dimensions 8.5"H x 6" W 2.5"D
- One year warranty

**CAF 743CA-WBX**      White

### Caframo Kona 12V Fan

- Weather resistant
- Extruded aluminum body
- UV stabilized plastic
- Stainless fasteners
- Cam lock suction cup for quick mounting and bracket for permanent mounting
- Adjustable tilting head
- Cam Lock tilt mechanism holds fan in any position
- Ultra low current draw, only 0.4 amps
- Variable speed, long-life motor
- Two year warranty



**CAF 817CA-BBX**      Black  
**CAF 817CA-WBX**      White

### Hella Turbo Fans

- Can be turned and pivoted in all directions, and locked in position
- Side, upright or pendant mounting
- Very quiet operation
- 150mm dia. fan blade with guard
- Pre-wired with 140mm cable
- Two speed switch
  - Speed I: 70 litres / second
  - Speed II: 95 litres / second
- Draws 0.3 amps on low & 0.5 amps on high
- H: 7-5/8" x W: 7-1/4" x D: 3-3/4"



**HLA 003361022**      12V White  
**HLA 003361002**      12V Black

### Hella Jet Fan

- 130 mm dia fan blade with guard
- Switch in front of the blade guard
- Side, upright or pendant mounting
- Can be fixed in any position
- Pre-wired with 140mm cable
- Output: 40 litres / second
- Power consumption: 3.5W
- H: 8" x W: 6"

HLA 006239022



### Wesmar 2-Speed Fan

This two-speed fan, with integral switch, is precision engineered to circulate a maximum amount of air with whisper-quiet, vibrationless operation. The all metal fan and cage is connected to the sturdy aluminum base by a spring loaded ball-joint swivel.

Motor draws 1.4 amps at 12 volts.

- Blade diameter: 6-1/2"
- Overall height: 8-3/4"
- Width: 7-1/4"

WES F1000-12V



### Guest Cabin Fan

Keeps the air moving when it's hot or humid and helps de-fog windows, too. Oscillates 120° horizontally, or can be operated from a stationary position. Also features vertical adjustment and may be mounted vertically or horizontally. Highly efficient compact 12 vdc motor is very quiet and draws only 1.2 amps. Three transparent blades and 7-1/2" vinyl-coated guard.

GUE 900



### Marine Works Glove Box Lock

Attractive black plastic lock for marine glove boxes. Can be locked for security or left in latch only position for easy access. Supplied with 2 keys.

MWK 49410



### Attwood Glove Box

The black plastic box and door are lightweight yet sturdy and durable. Door opens and closes easily on a S/S hinge pin. The door is lockable and comes with 2 keys.

- Inside box: 11-3/4" L x 4" W x 6-5/8" D
- Door: 13-3/4" L x 5-1/2" W
- Installation hole: 12" x 4-1/4"

ATT 2638-1

Parts:

ATT 2638-20-1 Replacement lock & keys



### Matworks Entrance Mats

High end, highly fade resistant, rubber backed, jet printed entrance mats.

MFM 10010

Welcome Aboard in navy 18" x 30"

MFM 10020

Welcome Aboard in green 18" x 30"

MFM 10080

Boat Shoes Only in navy 18" x 24"

MFM 10090

Welcome Aboard in blue half moon shape, 18" x 36."



### Dock Edge Aqua Mats

Useful in all environments indoors and out. Manufactured from a fast-drying resilient PVC compound specially formulated for mould and mildew prevention. Low profile tiles provide a fast draining, sure-grip surface to protect boat decks, storage lockers, floors and vehicles from damage caused by impact with hard or heavy objects. Can be cut easily to fit irregular areas.

- 6 tiles per package
- Dimensions: 12" x 12"

DOC 7100-F

Charcoal grey

DOC 7200-F

Super white

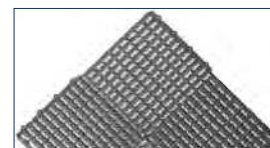

### 3M Dual Lock Resealable Fastening System Mini Packs

This system allows closure alternatives to zippers, screws, snaps, hooks and bolts. It offers greater flexibility, faster product assembly, smoother and cleaner exterior surfaces, improved product performance. Can be used on bare and painted metals, glass fibreglass, painted wood, ABS, acrylic, polycarbonate, polystyrene, rigid vinyl, etc.

- Comes with both male and female sides
- Audible snap on closure
- 5 times stronger than conventional hook & loop systems
- 1" x 4.9 yards

THR MP-3560

Clear

THR MP-3551/52

Black



### 3M Resealable Attachment System

Five times stronger than conventional hook and loop fasteners. Industrial strength adhesive holds backing securely in place. Use for attaching marine electronics. Secure boat cushions, floor mats or mount pictures on cabin walls. Keeps loose items secure until they are needed.

THR 06539

Four 1" x 3" strips

